

# MZN1

## Magnetic cylinder sensor

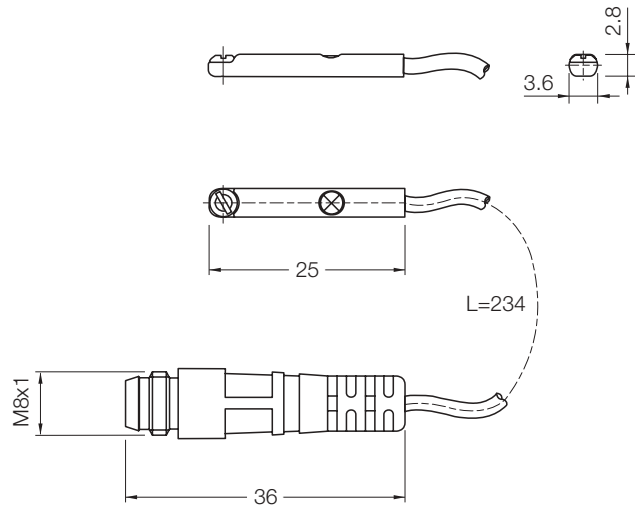

### Features



- ▶ Non-contact detection of piston position in pneumatic cylinders
- ▶ **Mountable from the top**
- ▶ For all common used roundslot cylinder e.g. Festo, SMC
- ▶ Plastic housing with clamping screw
- ▶ Connection cable or connector on cable
- ▶ Enclosure rating IP 67
- ▶ LED status indicator

### Accessories

Round connector

### Connection diagram

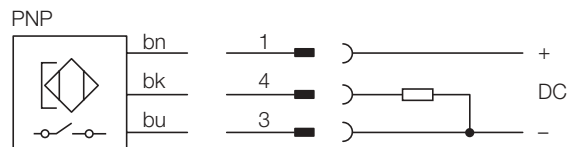



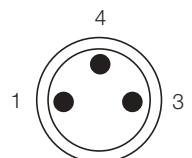

Wire colour	Contact	Assignment
bn brown	1	+ VDC
bk black	4	NO
bu blue	3	- VDC

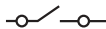

## Electrical and mechanical data

<b>Operating voltage</b> $U_b$	10 ... 30 V DC	<b>Short-circuit protected (pulsed)</b>	yes
<b>Ripple</b> $U_{PP}$	$\leq 10\%$ of $U_b$	<b>Reverse-polarity protected</b>	yes
<b>Voltage drop</b> $U_d$	$\leq 2,5$ V DC	<b>Enclosure rating</b> to DIN 40050	IP 67
<b>Power consumption</b> (inactive)	$\leq 8$ mA	<b>Shock and vibration stress</b>	30 g, 11 ms
<b>Continuous current</b> $I_a$	$\leq 70$ mA	<b>Ambient temperature</b> $T_a$	10 to 55 Hz, 1 mm - 25 ... + 75 °C
<b>Switching delay</b>	$\leq 0.1$ ms	<b>Housing material</b>	PA
<b>Hysteresis</b> H typ.	$\leq 1.5$ mT	<b>Connection cable 2 m</b>	PUR 3 x 0.09 mm <sup>2</sup>
<b>Repeatability</b> R	$\leq \pm 0.1$ mm	<b>Connection cable with M8x1 mm</b>	PUR
( $U_b$ and $T_a$ constant)			
<b>EMC</b>	to EN 60 947-5-2		

## Selection table

Sensing face	Switching output	Output function	Switching frequency in Hz	Connection type	Type	Order number
	PNP		1000	Cable 2 m	MZN1-06VPS-KUO	1022053
	PNP		1000	Cable w. M 8 x 1 mm	MZN1-06VPS-KPO	1022054
	PNP		1000	500 mm Cable w. M 8 x 1 knurled screw	MZN1-06VPS-KRD	1023985

# SICK

**Great Britain**  
Erwin Sick Ltd.  
Waldkirch House  
39 Hedley Road, St. Albans  
Hertfordshire AL 1 5BN  
☎ +44 17 27-83 11 21  
Fax +44 17 27-85 67 67  
erwin@sick.co.uk

**USA**  
SICK, Inc.  
6900 West 110th Street  
Bloomington, MN 55438  
☎ +1 (952) 9 41-67 80  
Fax +1 (952) 9 41-92 87  
WATS: 1-800-325-7425  
info@sickoptic.com

**Australia**  
Erwin Sick Optic-Electronic  
Pty. Ltd. Head Office, P.O. Box 214  
899 Heidelberg Road  
Ivanhoe, Vic. 3079, Australia  
☎ +61 39 49 74 10 0  
(0 08) 33 48 02 - toll free  
Fax +61 39 49 71 18 7  
sick@werple.net.au