

OD Hi Displacement Sensor



	Measurement range 30 ± 4 / 50 ± 10 / 80 ± 15 / 100 ± 40 / 250 ± 150 mm
Displacement sensors	

- **CMOS Technology:**
 - object independent measuring: shiny, dark;
 - highly precise measurement for quality improvement;
 - better in handling of multiple reflections from the surface.
- **Stand-alone Device:**
 - No additional outlay caused by external controller necessary
- **Setting and display on the device – quick, fast and easy set up**

Dimensional drawing

OD 30	OD 50	OD 80	OD 100	OD 250
-------	-------	-------	--------	--------

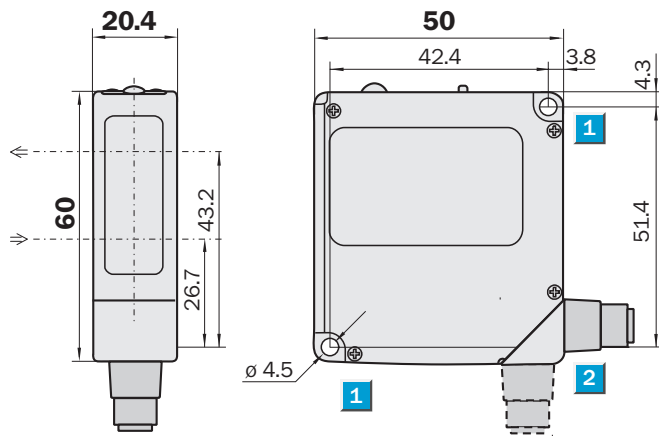

Adjustments possible

All types

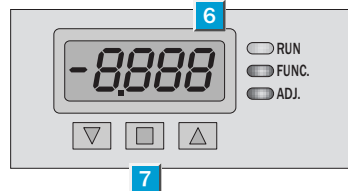
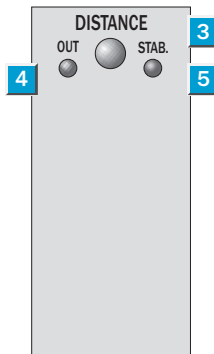

- 1** Mounting hole, \varnothing 4.5 mm
- 2** 2 m cable (5 m option) or M12 plug; 90° rotatable
- 3** Distance indicator
- 4** Output indicator (OUT)
- 5** Stability indicator
- 6** Display
- 7** Mode buttons

Connecting types

OD 30-04P152	OD 30-04N152	OD 30-04P850	OD 30-04N850
OD 50-10P152	OD 50-10N152	OD 50-10P850	OD 50-10N850
OD 80-15P152	OD 80-15N152	OD 80-15P850	OD 80-15N850
OD 100-40P152	OD 100-40N152	OD 100-40P850	OD 100-40N850
OD 250-150P152	OD 250-150N152	OD 250-150P850	OD 250-150N850

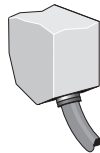

6 x 0.2 mm²

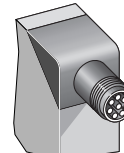
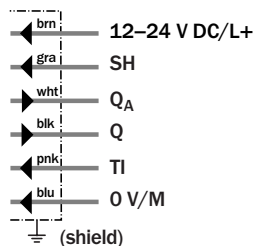

8-pin, M12

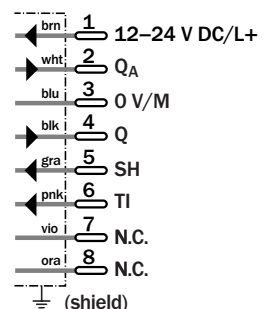

OD Hi Series Displacement sensors

Technical data	OD	30-04	30-04	50-10	50-10	80-15	80-15	100-40	100-40	250-150	250-150
		P152 ¹⁾	N152 ¹⁾	P152 ¹⁾	N152 ¹⁾	P152 ¹⁾	N152 ¹⁾	P152 ¹⁾	N152 ¹⁾	P152 ¹⁾	N152 ¹⁾
Measurement range	30 ± 4 mm										
	50 ± 10 mm										
	80 ± 15 mm										
	100 ± 40 mm										
	250 ± 150 mm ³⁾										
Light source	Laser category II, EN 60825: 1998										
Analogue output	4 ... 20 mA, 0 ... 300 Ω										
Switching outputs	PNP; 30 V/100 mA open collector										
	NPN; 30 V/100 mA open collector										
Accuracy	± 1%/6% ... 90 % rem. (FS ⁴⁾), ± 2% ⁵⁾										
Linearity	± 1%/6% ... 90 % rem. (FS ⁴⁾), ± 2% ⁵⁾										
Drift	± 0.08%/°C (FS ⁴⁾)										
Resolution of analogue output ⁶⁾	10/6/5/4/2/2 μm ⁷⁾										
	20/15/10/10/8/8 μm ⁷⁾										
	30/20/15/15/8/8 μm ⁷⁾										
	60/50/35/35/20/10 μm ⁷⁾										
	1000/400/200/75/50/25 μm ⁷⁾										
Analogue output freq. response – 3 dB	1000/s; 344/s; 85,6/s; 21,7/s; 5,47/s; 1,37/s ⁷⁾										
Teach-in-Input (TI)	NPN LOW = active, PNP HIGH = active										
Hold input (SH)	NPN LOW = active, PNP HIGH = active										
Timer	0 ... 10 s off/on delay, one shot, none										
VDE protection glass	III										
Sensitivity to ambient light	10,000 lx (sun), 3000 lx (artificial light)										
Supply voltage U _v	DC 12 ... 24 V, –5 %/+10 %										
Current consumption ⁸⁾	120 mA (bei 24 V)										
Warm-up time ⁹⁾	5 min. max.										
EMV, EMC ⁵⁾	EN 50081-2, EN 50082-2, EN 60947-5-2 ⁵⁾										
Enclosure rating	IP 67										
Circuit protection ¹⁰⁾	A, B, D										
Ambient temperature T _u ¹¹⁾	Operating: –10 ... +40 °C Storage: –20 ... +60 °C										
Housing	Zinc										

- 1) Connection types: 2 m cable
 2) Connection: plug part no.: 6 020 663
 3) Light spot diameter OD 250: 1 x 2 mm at 250 mm distance

- 4) FS = Full Scale = 8 mm/OD 30, 20 mm/OD 50, 30 mm/OD 80, 80 mm/OD 100, 300 mm/OD 250
 5) OD 250 only
 6) 90 % remission

- 7) 1/4/16/64/256/1024 avg.
 8) Without load
 9) For applications with max. resolution and accuracy

- 10) A = Inputs and outputs reverse-polarity protected
 B = Outputs short-circuit protected
 D = Interference pulse suppression
 11) Do not bend below 0 °C

Deviation/Light spot diameter OD 30-04

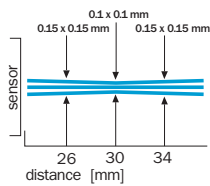
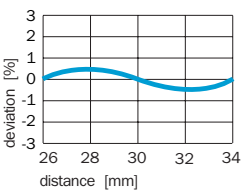

Deviation/Light spot diameter OD 50-10

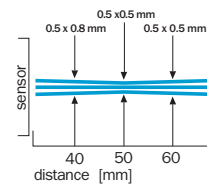
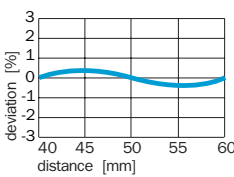

Deviation/Light spot diameter OD 80-15

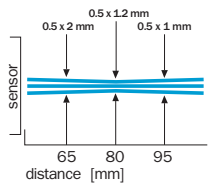
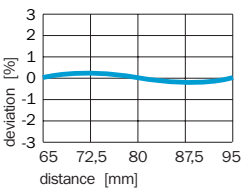

Deviation/Light spot diameter OD 100-40

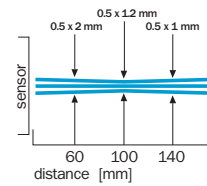
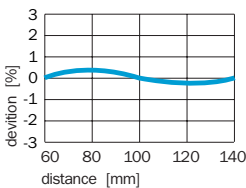

Order information

Type	Part no.
OD 30-04N152	6 025 033
OD 30-04P152	6 025 031
OD 30-04N850	6 025 034
OD 30-04P850	6 025 032
OD 50-10N152	6 025 037
OD 50-10P152	6 025 035
OD 50-10N850	6 025 038
OD 50-10P850	6 025 036
OD 80-15N152	6 025 041
OD 80-15P152	6 025 039
OD 80-15N850	6 025 042
OD 80-15P850	6 025 040
OD 100-40N152	6 025 045
OD 100-40P152	6 025 043
OD 100-40N850	6 025 046
OD 100-40P850	6 025 044
OD 250-150N152	6 028 095
OD 250-150P152	6 028 094
OD 250-150N850	6 028 097
OD 250-150P850	6 028 096

SICK

Great Britain
 Erwin Sick Ltd.
 Waldkirch House
 39 Hedley Road, St. Albans
 Hertfordshire AL 1 5BN
 ☎ +44 17 27-83 11 21
 Fax +44 17 27-85 67 67
 info@sick.co.uk

USA
 SICK, Inc.
 6900 West 110th Street
 Bloomington, MN 55438
 ☎ +1 (952) 9 41-67 80
 Fax +1 (952) 9 41-92 87
 WATS: 1-800-325-7425
 info@sickusa.com

Australia
 SICK PTY LTD
 P.O. Box 214
 899 Heidelberg Road
 Ivanhoe, Vic. 3079, Australia
 ☎ +61 39 49 74 10 0
 1800 33 48 02 - toll free
 Fax +61 39 49 71 18 7
 sales@sick.com.au