

W 2: Sub-Miniature Photoelectric Switch Range: Super-Small and Powerful

	Photoelectric proximity switches BGS
	Photoelectric proximity switches energetic, (V optics)
	Photoelectric reflex switches



	Through-beam photoelectric switches
--	-------------------------------------

The W 2 range offers particular benefits:

- Small housing dimensions allow fitting very close to objects.
- Fast commissioning, easy connection, alignment – ready.
- Laser-like light spot dimensions enable precise detection, e.g. for positioning tasks.
- Even transparent objects or product with reflective surfaces can be detected reliably and accurately.

The following W 2 options are available:

- Photoelectric proximity switches with background suppression and scanning distances of 15 mm and 30 mm.
- Energetic photoelectric proximity switches with “V” optics and scanning distances of 9 mm, 18 mm and 55 mm.
- Energetic photoelectric proximity switches with scanning distances of 34 mm and 115 mm.
- Photoelectric reflex switches with a scanning range of 1.5 m.
- Through-beam photoelectric proximity switches with scanning ranges of 0.5 m and 1.2 m.

Confined spaces in and around machinery – and yet the sensor must meet exacting requirements?

The Series W 2 photoelectric switches and photoelectric proximity switches, in two specially developed housing configurations, fit into the smallest spaces and are suitable for virtually any task. Largely insensitive to ambient light and unwanted background reflections, these sensors reliably perform their tasks, even in arduous daily industrial use.

► Fits in almost anywhere.

The WT 2 Flat photoelectric reflex switch is only 3.5 mm thick and reliably detects transparent and reflective objects.

▼ Well adaptable in cramped spaces. Laser-like light spot provides most precise positioning tasks.

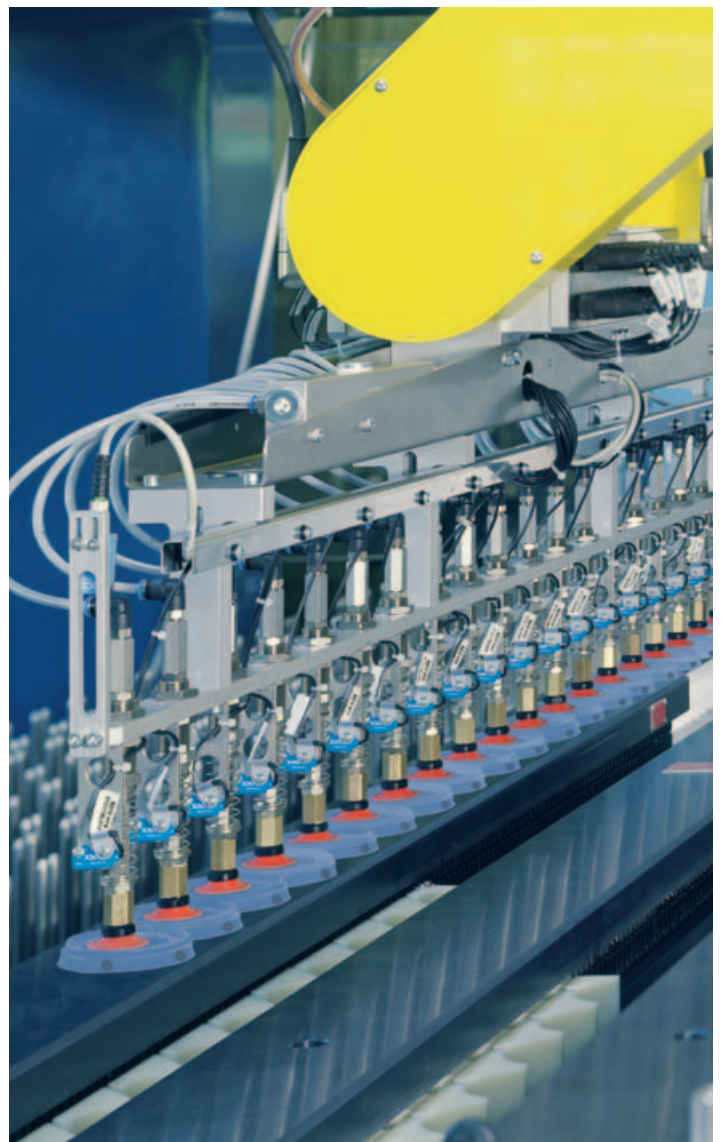
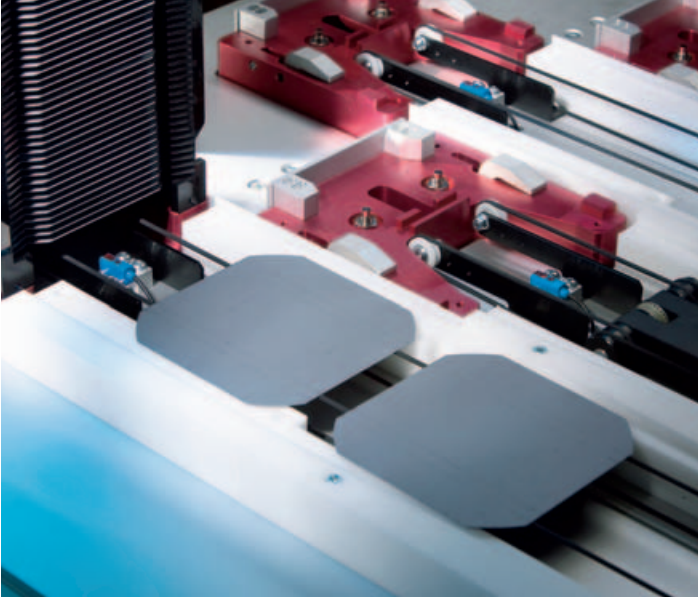

▲ Detection of transparent lids on a gripper arm.

◀ WL 2 Slim photoelectric reflex switch with high scanning range.

Photoelectric proximity switch, WT 2 Slim, BGS, red light

Scanning distance
1 ... 15/30 mm

Photoelectric proximity switch

- A focused, laser-like light spot makes the most precise detection jobs possible
- Insensitive to interference from critical backgrounds
- Sturdy housing with metal sleeves for M3 bolts

Dimensional drawing

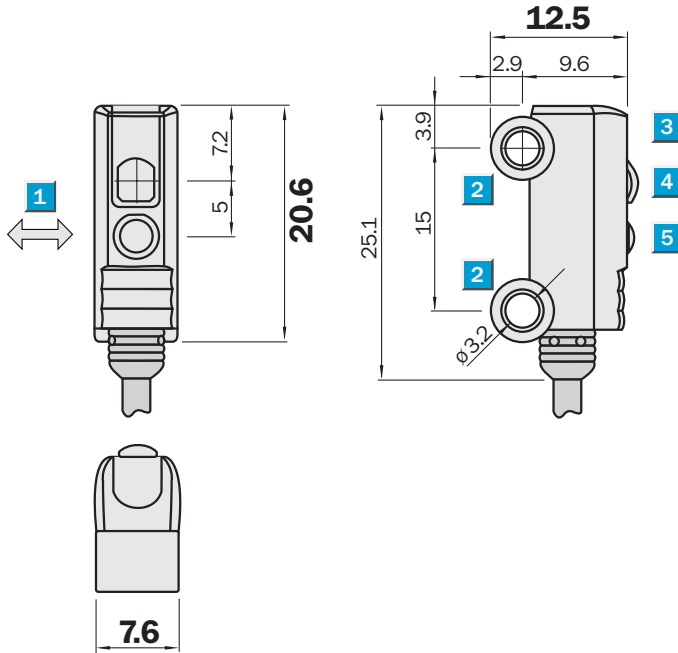

Connection type

WT2S-F131	WT2S-F211	WT2S-P411
WT2S-N111	WT2S-P211	WT2S-P431
WT2S-N131	WT2S-P231	
WT2S-P111		
WT2S-P131		

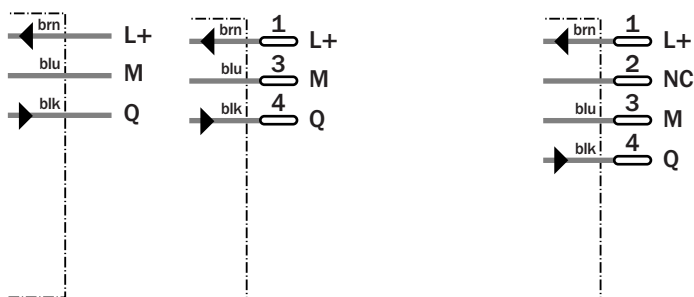
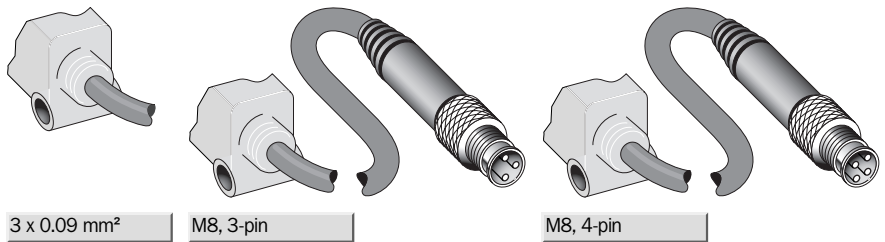

See chapter Accessories

Connector, M8, 3-pin

Connector, M8, 4-pin

Mounting systems

Technical specifications		WT2S-	F131	F211	N111	N131	P111	P131	P211	P231	P411	P431
Scanning distance typ. max.	1 ... 30 mm ¹⁾											
	1 ... 15 mm ¹⁾											
Light source, light type	Pin Point LED, Red light ²⁾											
Light spot diameter	Approx. 1.0 mm at 15 mm distance											
	Approx. 1.2 mm at 8 mm distance											
	Approx. 2.5 mm at 15 mm distance											
Supply voltage V_s	DC 10 ... 30 V ³⁾											
Ripple	< 5 V _{pp} ⁴⁾											
Power consumption	< 20 mA ⁵⁾											
Switching outputs	PNP, Q											
	NPN, Q											
Switching mode	Dark-switching											
	Light-switching											
Output current I _a max	< 50 mA											
Response time	< 0.6 ms ⁶⁾											
Switching frequency	800 Hz ⁷⁾											
Connection type	Cable, PVC, 2 m ⁸⁾											
	Cable with plug, M8, 3-pin, PVC, 200 mm ⁸⁾											
	Cable with plug, M8, 4-pin, PVC, 200 mm ⁸⁾											
VDE protection class	◆											
Circuit protection	V _s connections reverse-polarity protected / Output Q and Q not short-circuit protected / Interference suppression											
Enclosure rating	IP 67, IP 69K											
Ambient temperature operation	-20 °C ... +50 °C											
Ambient temperature storage	-40 °C ... +75 °C											
Weight	18 g											
	20 g											
Housing material	ABS, PMMA											

¹⁾ Object with 90% remission (based on standard white to DIN 5033)

at T_a = +25 °C

³⁾ Limit values

⁴⁾ may not exceed or fall short of

V_s tolerances

⁵⁾ without load

⁶⁾ Signal transit time with resistive load

⁷⁾ with light/dark ratio 1:1

⁸⁾ do not bend below 0 °C

Scanning distance and light spot diameter

Scanning distance 1 ... 30 mm

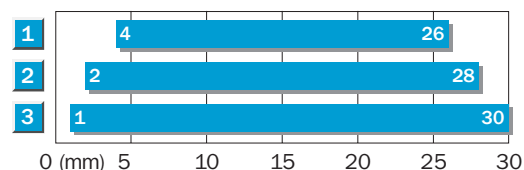

- 1 Scanning distance on black, 6 % remission
- 2 Scanning distance on grey, 18 % remission
- 3 Scanning distance on white, 90 % remission

Scanning distance 1 ... 15 mm

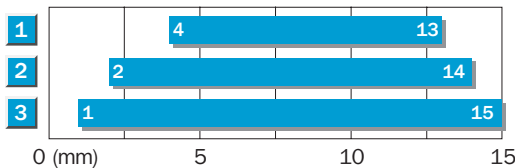

- 1 Scanning distance on black, 6 % remission
- 2 Scanning distance on grey, 18 % remission
- 3 Scanning distance on white, 90 % remission

Light spot diameter at SD 1 ... 30 mm

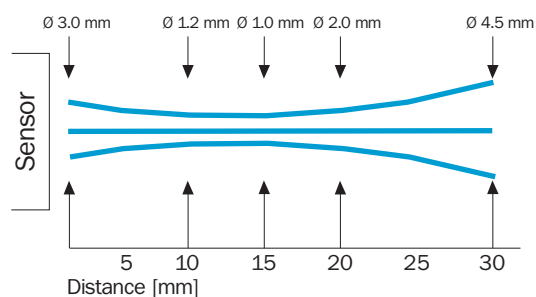

Light spot diameter at SD 1 ... 15 mm

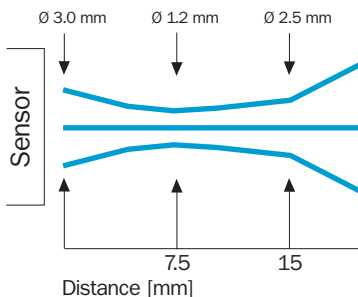

Ordering information

Type	Order no.
WT2S-F131	1 025 682
WT2S-F211	1 024 171
WT2S-N111	1 022 662
WT2S-N131	1 022 663
WT2S-P111	1 022 660
WT2S-P131	1 022 661
WT2S-P211	1 022 658
WT2S-P231	1 022 659
WT2S-P411	1 023 631
WT2S-P431	1 023 632

Photoelectric proximity switch, WT 2 Slim, energetic, V optics, red light

Scanning distance
1 ... 55 mm

Photoelectric proximity switch

- Precise, small light spot
- Extremely good size/performance ratio
- Sturdy housing with metal sleeves for M3 bolts

Dimensional drawing

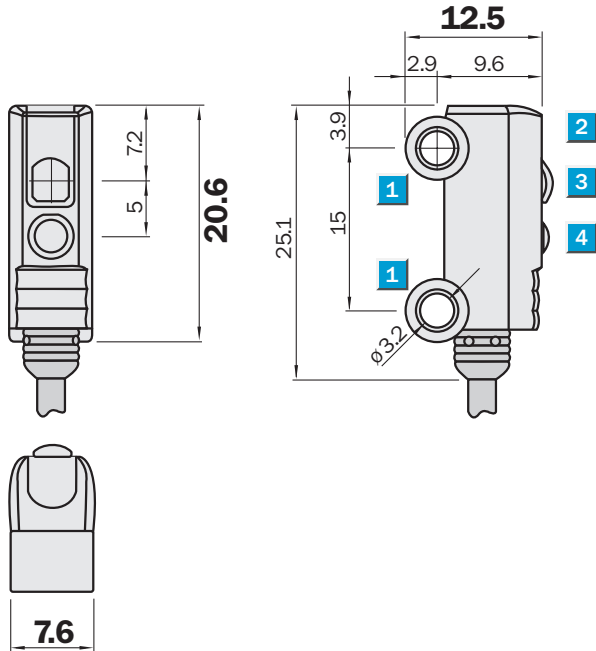

- 1** Mounting hole \varnothing 3.2 mm
- 2** LED signal strength indicator
- 3** Optical axis, receiver
- 4** Optical axis, sender



Connection type

WT2S-N161
WT2S-P161

WT2S-P261

WT2S-P461

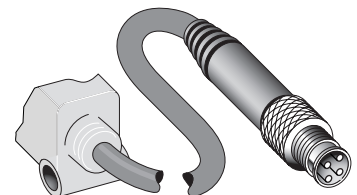
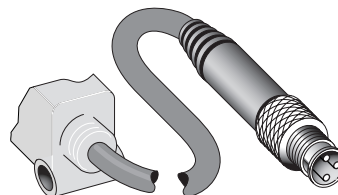
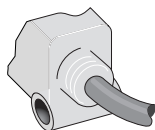

3 x 0.09 mm²

M8, 3-pin

M8, 4-pin

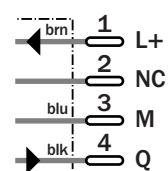
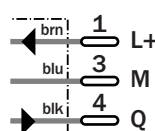
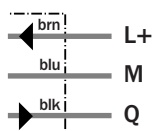

See chapter Accessories

- Connector, M8, 3-pin
- Connector, M8, 4-pin
- Mounting systems

Technical specifications		WT2S-	N161	P161	P261	P461							
Scanning distance typ. max.	1 ... 55 mm ¹⁾												
Light source, light type	Pin Point LED, Red light ²⁾												
Light spot diameter	Approx. 3.5 mm at 50 mm distance												
Supply voltage V_s	DC 10 ... 30 V ³⁾												
Ripple	< 5 V _{pp} ⁴⁾												
Power consumption	< 20 mA ⁵⁾												
Switching outputs	NPN, Q												
	PNP, Q												
Switching mode	Light-switching												
Output current I_a max	< 50 mA												
Response time	< 0.6 ms ⁶⁾												
Switching frequency	800 Hz ⁷⁾												
Connection type	Cable, PVC, 2 m ⁸⁾												
	Cable with plug, M8, 3-pin, PVC, 200 mm ⁸⁾												
	Cable with plug, M8, 4-pin, PVC, 200 mm ⁸⁾												
VDE protection class	⊖												
Circuit protection	V_s connections reverse-polarity protected / Output Q and Q not short-circuit protected / Interference suppression												
Enclosure rating	IP 67, IP 69K												
Ambient temperature operation	-20 °C ... +50 °C												
Ambient temperature storage	-40 °C ... +75 °C												
Weight	18 g												
	20 g												
Housing material	ABS, PMMA												

¹⁾ Object with 90% remission (based on standard white to DIN 5033)

²⁾ Average service life 75,000 h

at $T_a = +25^\circ\text{C}$

³⁾ Limit values

⁴⁾ may not exceed or fall short of

V_s tolerances

⁵⁾ without load

⁶⁾ Signal transit time with resistive load

⁷⁾ with light/dark ratio 1:1

⁸⁾ do not bend below 0 °C

Scanning distance and light spot diameter

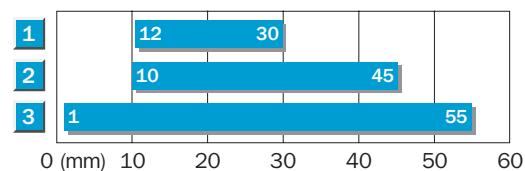

- 1 Scanning distance on black, 6 % remission
- 2 Scanning distance on grey, 18 % remission
- 3 Scanning distance on white, 90 % remission

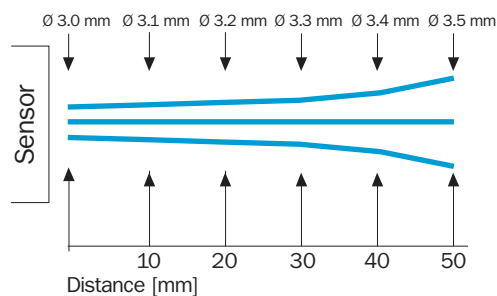

Ordering information

Type	Order no.
WT2S-N161	1 022 665
WT2S-P161	1 022 664
WT2S-P261	1 023 640
WT2S-P461	1 023 641

Scanning distance
1/2 ... 9/18 mm

Photoelectric proximity switch

- Detection of transparent and reflective objects
- Robust housing with metal-reinforced fixing holes
- Simple adjustment. Connect, align - ready
- No external amplifier required. Can be directly connected to the machine control system

Dimensional drawing

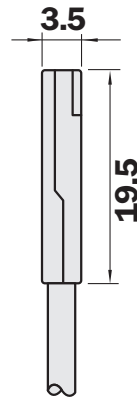
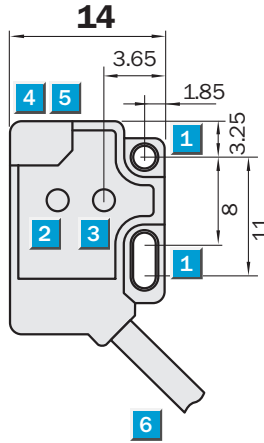

- 1 Mounting hole \varnothing 2.1 mm
- 2 Optical axis, sender
- 3 Optical axis, receiver
- 4 LED indicator orange; output active
- 5 LED indicator green; strength indicator
- 6 Connection



See chapter Accessories

- Connector, M8, 3-pin
- Connector, M8, 4-pin

Connection type

WT2F-N140
WT2F-N170
WT2F-P140
WT2F-P170

WT2F-P240
WT2F-P270

WT2F-P440
WT2F-P470

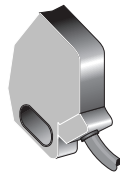

3 x 0.09 mm²

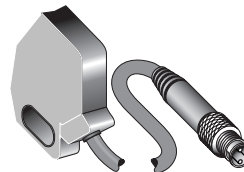
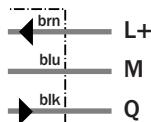

M8, 3-pin

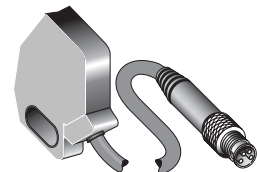
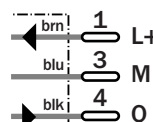

M8, 4-pin

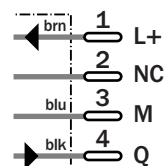

Technical specifications		WT2F-	N140	N170	P140	P170	P240	P270	P440	P470
Scanning distance typ. max.	2 ... 18 mm ¹⁾									
	1 ... 9 mm ¹⁾									
Operating distance	2 ... 15 mm ¹⁾									
	1 ... 8 mm ¹⁾									
Light source, light type	LED, Red light, 660 nm ²⁾									
Supply voltage V_s	DC 12 ... 24 V ³⁾									
Ripple	≤ 5 V _{pp} ⁴⁾									
Power consumption	≤ 20 mA ⁵⁾									
Switching outputs	NPN: open collector: Q									
	PNP: open collector: Q									
Switching mode	Light-switching									
Signal voltage PNP HIGH / LOW	V _s - 1.8 V / approx. 0 V									
Signal voltage NPN HIGH / LOW	Approx. V _s / < 1.8 V									
Output current I _a max	≤ 50 mA									
Response time	≤ 0.5 ms ⁶⁾									
Switching frequency	1,000 Hz ⁷⁾									
Connection type	Cable, PVC, 2 m ⁸⁾									
	Cable with plug, M8, 3-pin, PVC, 200 mm ⁸⁾									
	Cable with plug, M8, 4-pin, PVC, 200 mm ⁸⁾									
VDE protection class	◆									
Circuit protection	V _s connections reverse-polarity protected / In-/outputs short-circuit protected / Outputs overcurrent and short-circuit protected									
Enclosure rating	IP 67									
Ambient temperature operation	-20 °C ... +50 °C									
Ambient temperature storage	-40 °C ... +75 °C									
Weight	Approx. 20 g									
Housing material	PC / PBT, PC									

¹⁾ Object with 90% remission (based on standard white to DIN 5033)

²⁾ Average service life 100,000 h

at T_a = +25 °C

³⁾ ± 10%

⁴⁾ may not exceed or fall short of

V_s tolerances

⁵⁾ without load

⁶⁾ Signal transit time with resistive load

⁷⁾ with light/dark ratio 1:1

⁸⁾ do not bend below 0 °C

Scanning distance and function reserve

Scanning distance 2 ... 18 mm

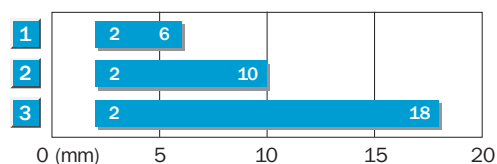

- 1 Scanning distance on black, 6 % remission
- 2 Scanning distance on grey, 18 % remission
- 3 Scanning distance on white, 90 % remission

Scanning distance 1 ... 9 mm

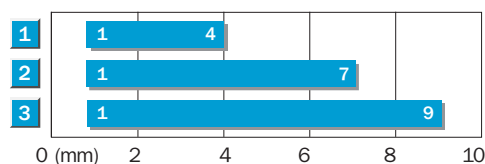

- 1 Scanning distance on black, 6 % remission
- 2 Scanning distance on grey, 18 % remission
- 3 Scanning distance on white, 90 % remission

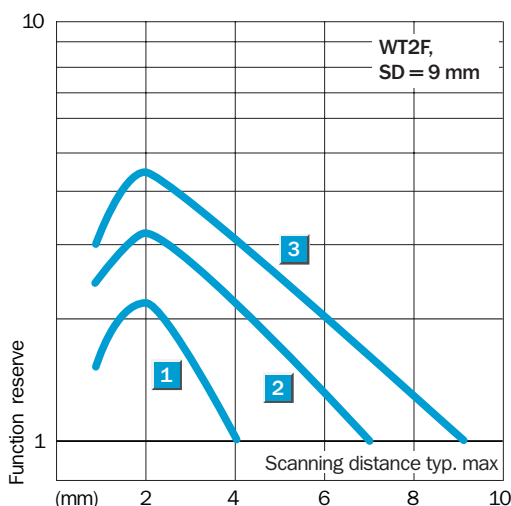
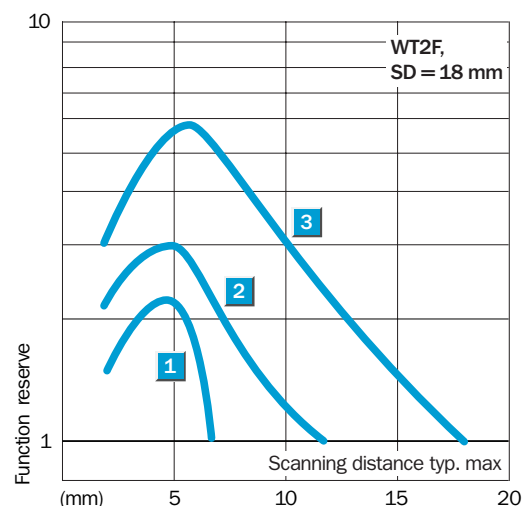

Ordering information

Type	Order no.
WT2F-N140	6 030 583
WT2F-N170	6 030 587
WT2F-P140	6 030 584
WT2F-P170	6 030 588
WT2F-P240	6 030 585
WT2F-P270	6 030 589
WT2F-P440	6 030 586
WT2F-P470	6 030 590

Scanning distance
2/4 ... 34/115 mm

Photoelectric proximity switch

- Robust housing with metal-reinforced fixing holes
- Simple adjustment. Connect, align - ready
- No external amplifier required. Can be directly connected to the machine control system

Dimensional drawing

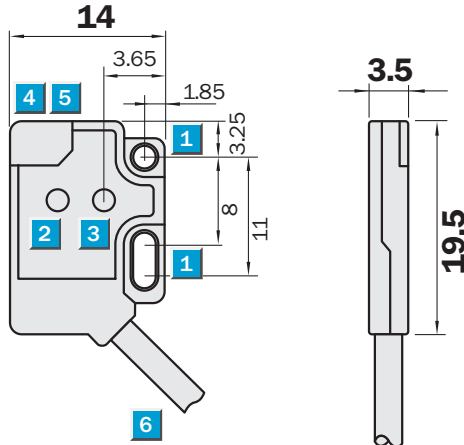

- 1 Mounting hole \varnothing 2.1 mm
- 2 Optical axis, sender
- 3 Optical axis, receiver
- 4 LED indicator orange; output active
- 5 LED indicator green; strength indicator
- 6 Connection



See chapter Accessories

Connector, M8, 3-pin

Connector, M8, 4-pin

Connection type

WT2F-N150	WT2F-P250	WT2F-P450
WT2F-N180	WT2F-P280	WT2F-P480
WT2F-P150		
WT2F-P180		

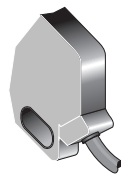

3 x 0.09 mm²

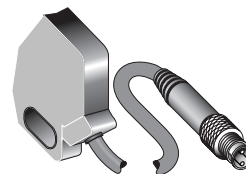

M8, 3-pin

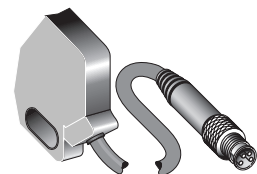
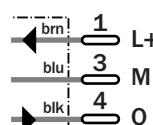

M8, 4-pin

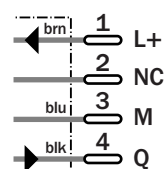

Technical specifications		WT2F-	N150	N180	P150	P180	P250	P280	P450	P480
Scanning distance typ. max.	2 ... 34 mm ¹⁾									
	4 ... 115 mm ¹⁾									
Operating distance	2 ... 30 mm ¹⁾									
	4 ... 100 mm ¹⁾									
Light source, light type	LED, Red light, 660 nm ²⁾									
Supply voltage V_s	DC 12 ... 24 V ³⁾									
Ripple	≤ 5 V _{pp} ⁴⁾									
Power consumption	≤ 20 mA ⁵⁾									
Switching outputs	NPN: open collector: Q									
	PNP: open collector: Q									
Switching mode	Light-switching									
Signal voltage PNP HIGH / LOW	V _s - 1.8 V / approx. 0 V									
Signal voltage NPN HIGH / LOW	Approx. V _s / < 1.8 V									
Output current I _a max	≤ 50 mA									
Response time	≤ 0.5 ms ⁶⁾									
Switching frequency	1,000 Hz ⁷⁾									
Connection type	Cable, PVC, 2 m ⁸⁾									
	Cable with plug, M8, 3-pin, PVC, 200 mm ⁸⁾									
	Cable with plug, M8, 4-pin, PVC, 200 mm ⁸⁾									
VDE protection class	◆									
Circuit protection	V _s connections reverse-polarity protected / In-/outputs short-circuit protected / Outputs overcurrent and short-circuit protected									
Enclosure rating	IP 67									
Ambient temperature operation	-20 °C ... +50 °C									
Ambient temperature storage	-40 °C ... +75 °C									
Weight	Approx. 20 g									
Housing material	PC / PBT, PC									

¹⁾ Object with 90% remission (based on standard white to DIN 5033)

²⁾ Average service life 100,000 h

at T_a = +25°C

³⁾ ± 10%

⁴⁾ may not exceed or fall short of

V_s tolerances

⁵⁾ without load

⁶⁾ Signal transit time with resistive load

⁷⁾ with light/dark ratio 1:1

⁸⁾ do not bend below 0 °C

Scanning distance and function reserve

Scanning distance 4 ... 115 mm

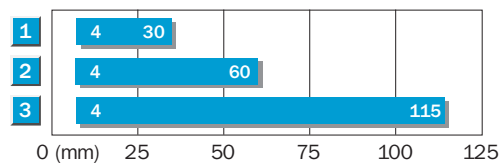

- 1 Scanning distance on black, 6 % remission
- 2 Scanning distance on grey, 18 % remission
- 3 Scanning distance on white, 90 % remission

Scanning distance 2 ... 34 mm

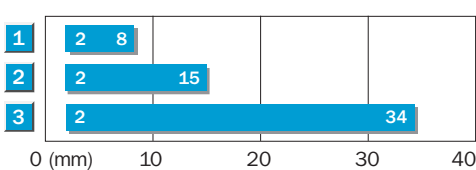

- 1 Scanning distance on black, 6 % remission
- 2 Scanning distance on grey, 18 % remission
- 3 Scanning distance on white, 90 % remission

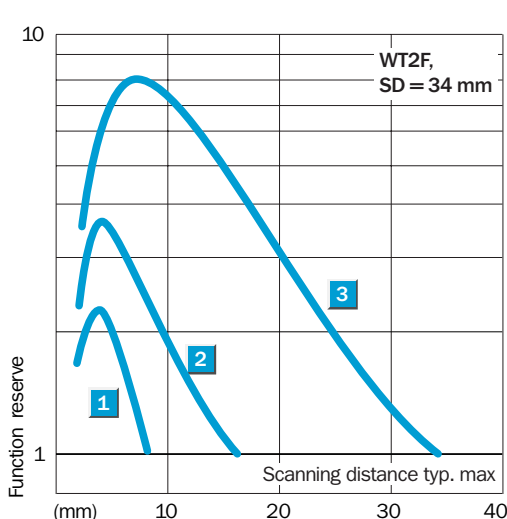
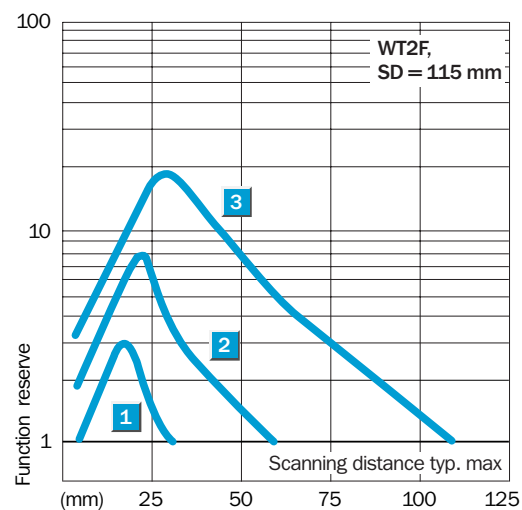

Ordering information

Type	Order no.
WT2F-N150	6 030 576
WT2F-N180	6 030 572
WT2F-P150	6 030 580
WT2F-P180	6 030 573
WT2F-P250	6 030 581
WT2F-P280	6 030 574
WT2F-P450	6 030 582
WT2F-P480	6 030 575

Photoelectric reflex switch, WL 2 Slim, red light

Scanning range
0.04 ... 0.8 m

Photoelectric reflex switch

- Extremely good size /performance ratio
- Easy and fast alignment using ball joint bracket
- Sturdy housing with metal sleeves for M3 bolts

Dimensional drawing

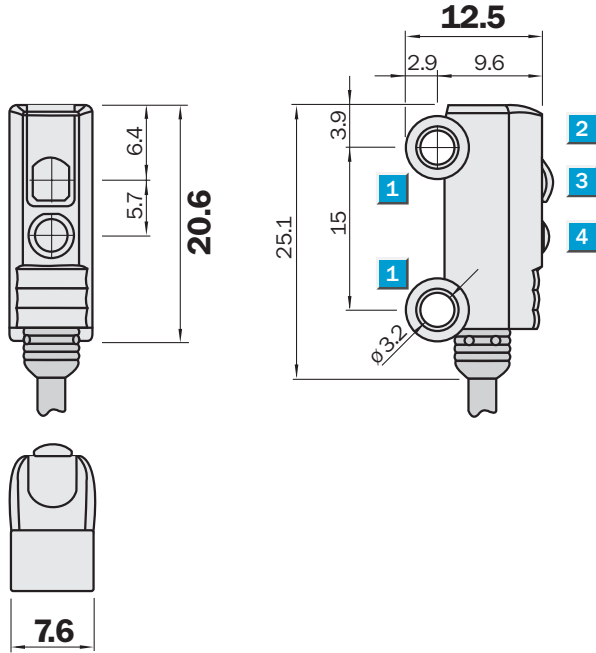

- 1** Mounting hole Ø 3.2 mm
- 2** LED signal strength indicator
- 3** Optical axis, receiver
- 4** Optical axis, sender



Connection type

WL2S-E111	WL2S-F211	WL2S-F411
WL2S-F111	WL2S-P211	
WL2S-N111		
WL2S-P111		

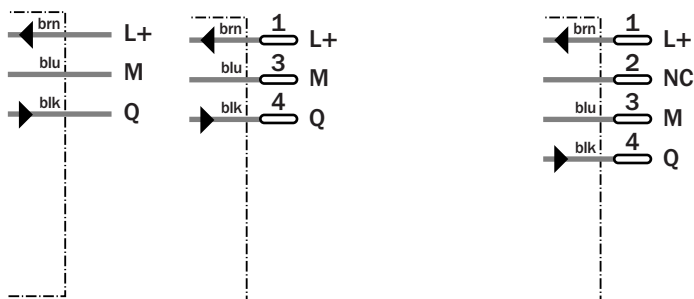
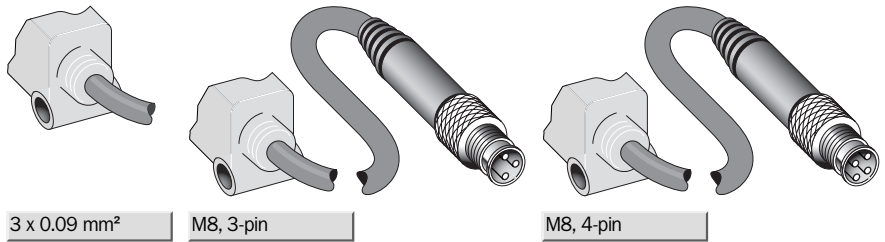

See chapter Accessories

Connector, M8, 3-pin
Connector, M8, 4-pin
Mounting systems
Reflectors

Technical specifications		WL2S-	E111	F111	F211	F411	N111	P111	P211			
Scanning range typ. max.	0.04 ... 0.8 m											
Scanning range, recommended	0.04 ... 0.4 m											
Relating to	Reflector PL 20 A											
Light source, light type	Pin Point LED, Red light ¹⁾											
Light spot diameter	10 mm at 100 mm distance											
Supply voltage V_s	DC 10 ... 30 V ²⁾											
Ripple	< 5 V _{pp} ³⁾											
Power consumption	< 20 mA ⁴⁾											
Switching outputs	NPN, Q											
	PNP, Q											
Switching mode	Dark-switching											
	Light-switching											
Output current I_a max	< 50 mA											
Response time	< 0.6 ms ⁵⁾											
Switching frequency	800 Hz ⁶⁾											
Connection type	Cable, PVC, 2 m ⁷⁾											
	Cable with plug, M8, 3-pin, PVC, 200 mm ⁷⁾											
	Cable with plug, M8, 4-pin, PVC, 2 m ⁷⁾											
VDE protection class	◆											
Circuit protection	V_s connections reverse-polarity protected / Output Q and Q not short-circuit protected / Interference suppression											
Enclosure rating	IP 67, IP69K											
Ambient temperature operation	-20 °C ... +50 °C											
Ambient temperature storage	-40 °C ... +75 °C											
Weight	18 g											
	20 g											
Housing material	ABS, PMMA											

¹⁾ Average service life 75,000 h at $T_a = +25^\circ\text{C}$
²⁾ Limit values of V_s tolerances
³⁾ may not exceed or fall short
⁴⁾ without load
⁵⁾ Signal transit time with resistive load
⁶⁾ with light/dark ratio 1:1
⁷⁾ do not bend below 0 °C

Scanning range and function reserve

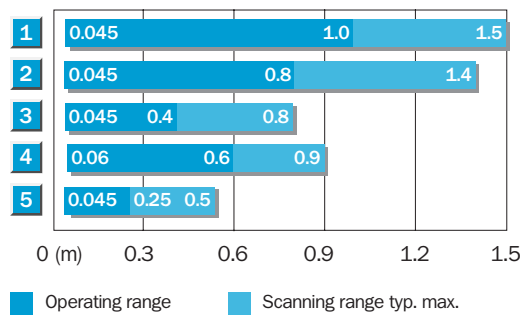

Reflector Type	Operating range
1 PL 40 A	0.045 ... 1.0 m
2 PL 30 A	0.045 ... 0.8 m
3 PL 20 A	0.045 ... 0.4 m
4 PL 22	0.06 ... 0.6 m
5 PL 10 F *)	0.045 ... 0.25 m

*) With reflector arrangement along the sensor axis

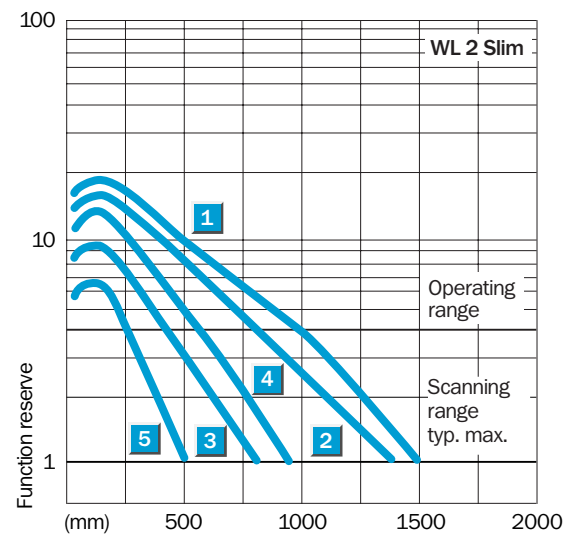

Ordering information	
Type	Order no.
WL2S-E111	1 022 667
WL2S-F111	1 022 666
WL2S-F211	1 023 868
WL2S-F411	1 023 644
WL2S-N111	1 023 870
WL2S-P111	1 023 869
WL2S-P211	1 024 249

Through-beam photoelectric switch, WS/WE 2 Slim, red light



Scanning range
0 ... 1.2 m

Through-beam photoelectric

- Excellent size/performance ratio
- Sturdy housing with metal sleeves for M3 bolts

Dimensional drawing

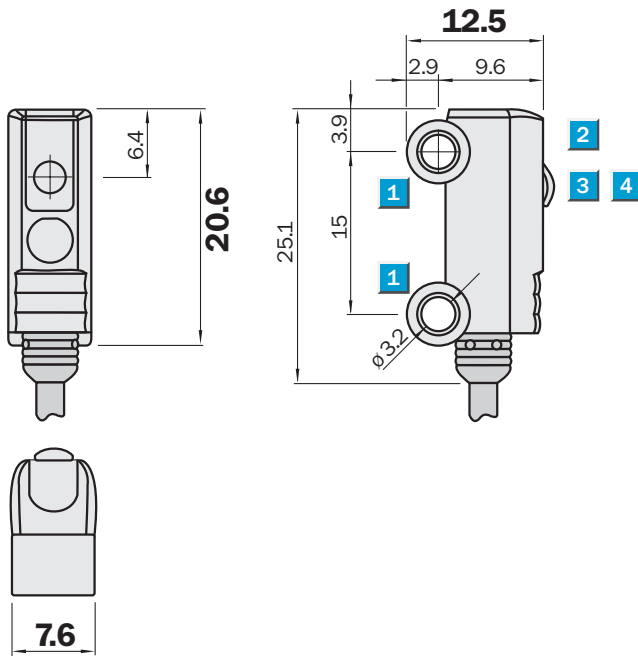

- 1 Mounting hole \varnothing 3.2 mm
- 2 LED signal strength indicator
- 3 Optical axis, receiver
- 4 Optical axis, sender

Connection type

WS/WE2S-E113

WS/WE2S-F213

WS/WE2S-F113

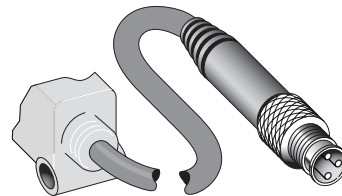
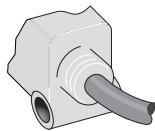

Sender 2 x 0.09 mm²

M8, 3-pin

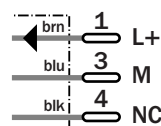
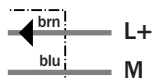

Receiver 3 x 0.09 mm²

M8, 3-pin

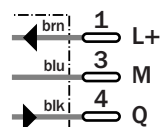
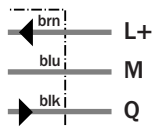

See chapter Accessories

Connector, M8, 3-pin

Mounting systems

Technical specifications		WS/WE2S-	E113	F113	F213							
Scanning range typ. max.	0 ... 1.2 m											
Scanning range, recommended	0 ... 1 m											
Light source, light type	Pin Point LED, Red light ¹⁾											
Light spot diameter	10 mm at 100 mm distance											
Supply voltage V_s	DC 10 ... 30 V ²⁾											
Ripple	< 5 V _{pp} ³⁾											
Power consumption, sender	< 20 mA ⁴⁾											
Power consumption, receiver	< 10 mA ⁴⁾											
Switching outputs	NPN, Q											
	PNP, Q											
Switching mode	Dark-switching											
Output current I_a max	< 50 mA											
Response time	< 2.5 ms ⁵⁾											
Switching frequency	200 Hz ⁶⁾											
Connection type	Cable, PVC, 2 m ⁷⁾											
	Cable with plug, M8, 3-pin, PVC, 200 mm ⁷⁾											
VDE protection class	◆											
Circuit protection	V_s connections reverse-polarity protected / Output Q and Q not short-circuit protected / Interference suppression											
Enclosure rating	IP 67, IP69K											
Ambient temperature operation	-20 °C ... +50 °C											
Ambient temperature storage	-40 °C ... +75 °C											
Weight	36 g											
	40 g											
Housing material	ABS, PMMA											

¹⁾ Average service life 75,000 h at $T_a = +25^\circ\text{C}$

²⁾ Limit values

³⁾ may not exceed or fall short of

V_s tolerances
⁴⁾ without load

⁵⁾ Signal transit time with resistive load

⁶⁾ with light/dark ratio 1:1

⁷⁾ do not bend below 0 °C

Scanning distance and function reserve

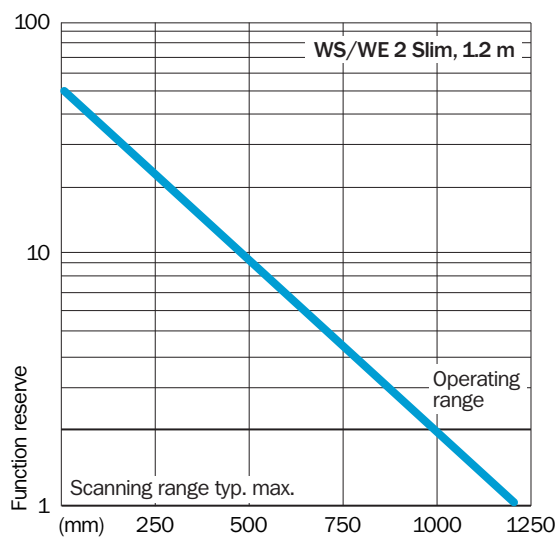
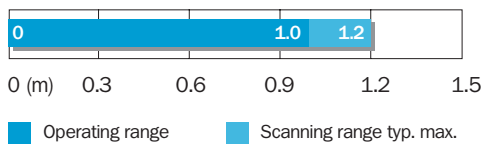

Ordering information

Type	Order no.
WS/WE2S-E113	1 022 669
WS/WE2S-F113	1 022 668
WS/WE2S-F213	1 023 650

Through-beam photoelectric switch, WS/WE 2 Flat, red light



Scanning range
0 ... 0.5 m

Through-beam photoelectric

- Robust housing with metal-reinforced fixing holes
- Simple adjustment.
Connect, align - ready
- No external amplifier required.
Can be directly connected to the machine control system

Dimensional drawing

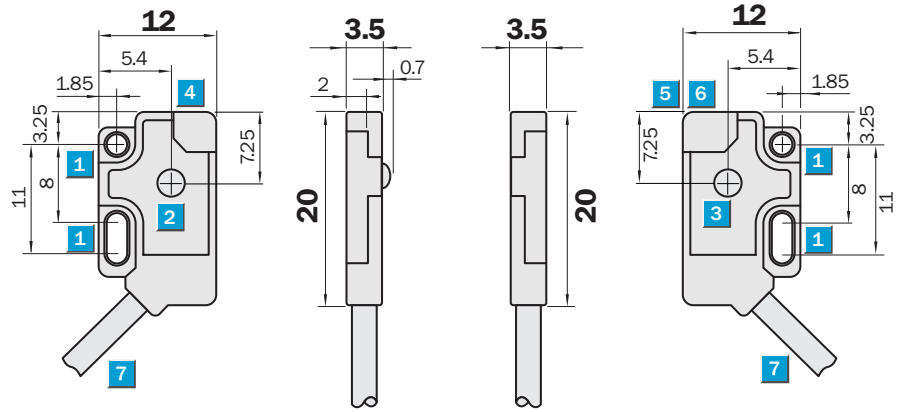

- 1 Mounting hole \varnothing 2.1 mm
- 2 Optical axis, sender
- 3 Optical axis, receiver
- 4 LED indicator green; supply voltage
- 5 LED indicator orange; output active
- 6 LED indicator green; strength indicator
- 7 Connection



Connection type

WS/WE2F-E110
WS/WE2F-F110
WS/WE2F-N110

WS/WE2F-F210
WS/WE2F-P210

WS/WE2F-F410

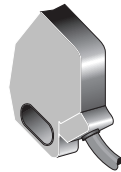

Sender 2 x 0.09 mm²

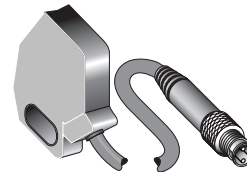
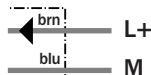

M8, 3-pin

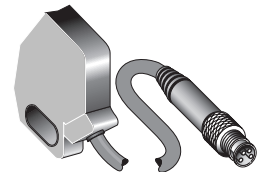
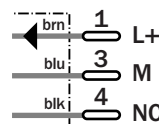

M8, 4-pin

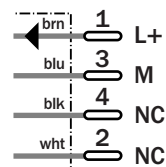

Receiver 3 x 0.09 mm²

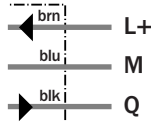

M8, 3-pin

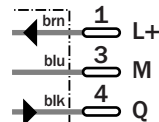

M8, 4-pin

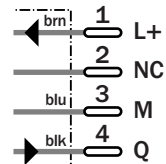

See chapter Accessories

- Connector, M8, 3-pin
- Connector, M8, 4-pin

Technical specifications		WS/WE2F-	E110	F110	F210	F410	N110	P210				
Scanning range typ. max.	0 ... 0.5 m											
Scanning range, recommended	0 ... 0.4 m											
Light source, light type	LED, Red light, 660 nm ¹⁾											
Supply voltage V _s	DC 12 ... 24 V ²⁾											
Ripple	≤ 5 V _{pp} ³⁾											
Power consumption, sender	≤ 10 mA											
Power consumption, receiver	≤ 15 mA ⁴⁾											
Switching outputs	NPN: open collector: Q											
	PNP: open collector: Q											
Switching mode	Dark-switching											
	Light-switching											
Signal voltage PNP HIGH / LOW	V _s - 1.8 V / approx. 0 V											
Signal voltage NPN HIGH / LOW	Approx. V _s / < 1.8 V											
Output current I _a max	≤ 50 mA											
Response time	≤ 0.5 ms ⁵⁾											
Switching frequency	1,000 Hz ⁶⁾											
Connection type	Cable, PVC, 2 m ⁷⁾											
	Cable with plug, M8, 3-pin, PVC, 200 mm ⁷⁾											
	Cable with plug, M8, 4-pin, PVC, 200 mm ⁷⁾											
VDE protection class	⊖											
Circuit protection	V _s connections reverse-polarity protected / In-/outputs short-circuit protected / Outputs overcurrent and short-circuit protected											
Enclosure rating	IP 67											
Ambient temperature operation	-20 °C ... +50 °C											
Ambient temperature storage	-40 °C ... +75 °C											
Weight	Approx. 35 g											
	Approx. 20 g											
Housing material	PC / PBT, PC											

¹⁾ Average service life 100,000 h at T_a = +25 °C
²⁾ ± 10%
³⁾ may not exceed or fall short of
⁴⁾ V_s tolerances without load
⁵⁾ Signal transit time with resistive load
⁶⁾ with light/dark ratio 1:1
⁷⁾ do not bend below 0 °C

Scanning distance and function reserve

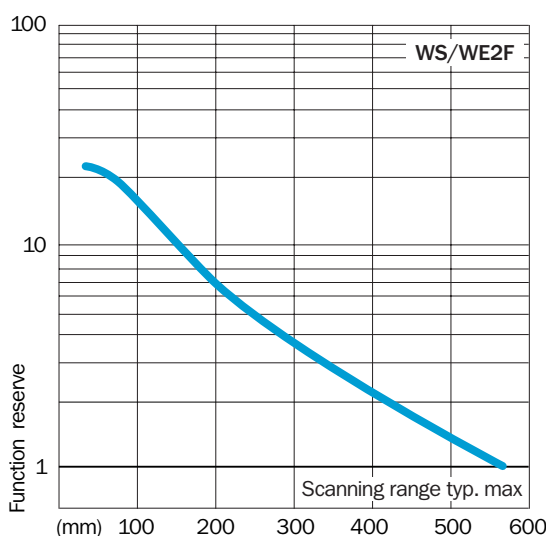
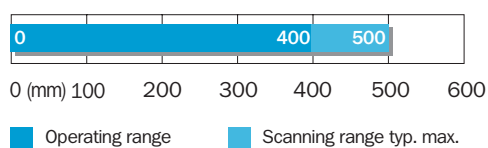

Ordering information	
Type	Order no.
WS/WE2F-E110	6 030 554
WS/WE2F-F110	6 030 569
WS/WE2F-F210	6 030 570
WS/WE2F-F410	6 030 571
WS/WE2F-N110	6 030 540
WS/WE2F-P210	6 030 566