



W250: Compact photoelectric switch series for a broad range of applications

	Photoelectric proximity switches, BGS
	Photoelectric reflex switches
	Through-beam photoelectric switches



Light-/dark-switching via control cable halves the number of device options and reduces stockholding.

Overview of W250:

- Universal supply voltage (DC or DC/AC) in a compact housing simplifies integration into machines,
- Visible light beam aids adjustment,
- light-/dark-switching reduces stockholding cost by reducing the number of variant required,
- supplied complete and ready for use, as mounting brackets and reflector (WL250 only) are included in the supply.

The W250 family of photoelectric switches features a special combination which integrates both the DC and DC/AC version in a very compact housing. The cable version or the rotatable plug version gives the W250 flexibility for system integration. During adjustments to sensitivity and scanning distance, the user is supported by an easily readable positioning display.

Principal areas of application:

- Mechanical engineering,
- Timber industry,
- Storage and materials handling,
- Bottling systems,
- Door/gate access control.

► The compact housing of the WL250 photoelectric reflex switch ensures optimum integration in materials handling applications.

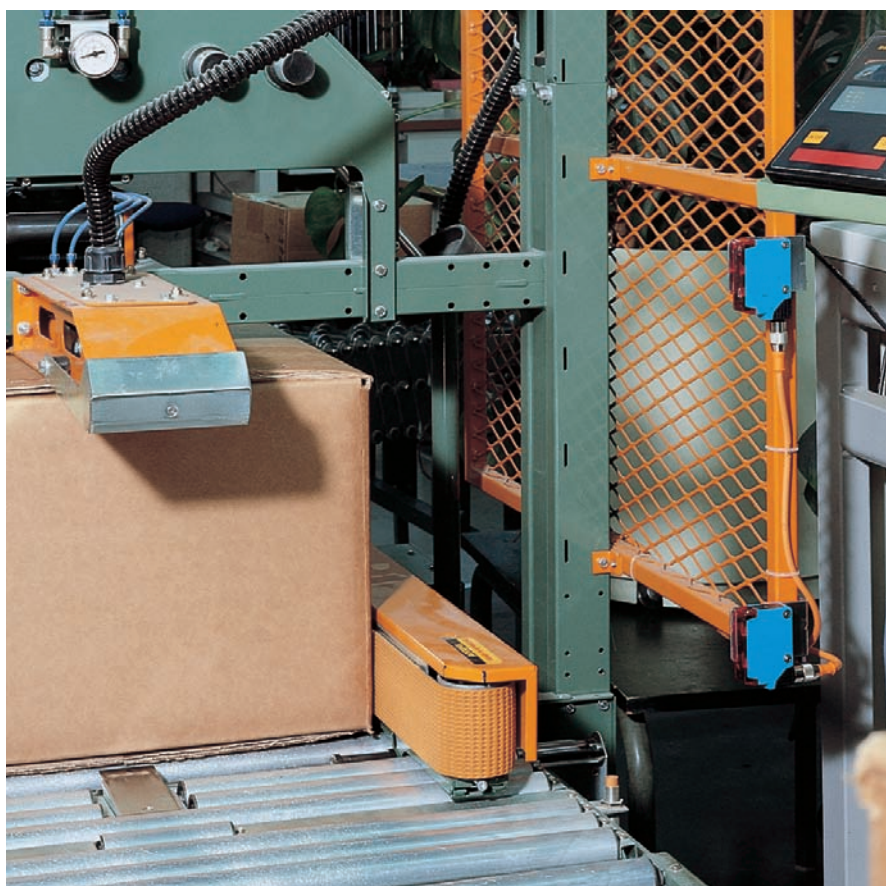

◄ Height control on a packaging line – implemented with the WT250 photoelectric proximity switch

Scanning distance
200 ... 1000 mm
 Photoelectric proximity switches

- Background suppression
- Scanning distance adjustment (2 turns) with position indicator (270°)
- Visible red light as an alignment aid
- Flexibility at the mounting position with rotatable plug connector

Dimensional drawing

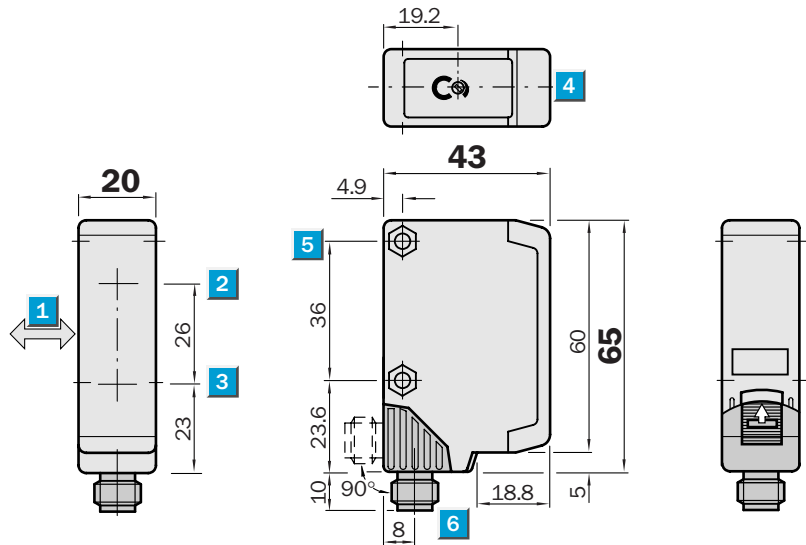

Adjustments possible

WT250-P172
WT250-P470
WT250-N172
WT250-N470

- 1 Standard direction of the material to be scanned
- 2 Transmission axis
- 3 Reception axis
- 4 Red LED signal strength indicator
- 5 Through hole Ø 4.2 mm, for M4 hexagon nut on both sides
- 6 Connection cable or M12 plug – 4-pin; plug position rotatable by 90° (V > H),
V → vertical final position
H → horizontal final position; can be locked with slider
- 7 Scanning distance adjustment (2 turns), over-turn protected
- 8 Position indicator for scanning distance setting (270°)

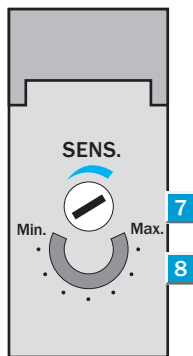

Connection types

WT250-P172	WT250-P470
WT250-N172	WT250-N470

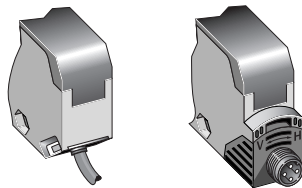

4 x 0,18 mm ²	4-pin, M12
--------------------------	------------

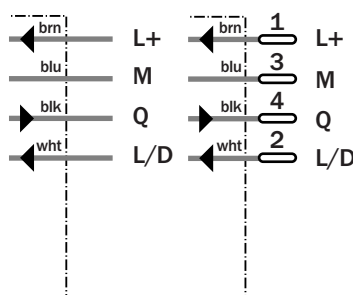

See chapter Accessories

- Cables and connectors
- Mounting systems*)

*) Mounting bracket included with delivery

Technical data		WT250-	P172	P470	N172	N470						
Scanning distance, typ. max.	200 ... 1000 mm ¹⁾											
Recommended operating scanning dist.	200 ... 1000 mm ¹⁾											
Scanning distance, adjustable	Potentiometer, 2 rotations, with position indicator											
Light source²⁾	LED, visible red light											
Light spot diameter	Approx. 70 mm at 1000 mm											
Aperture angle sender	Approx. 3°											
Supply voltage V_S	10 ... 30 V DC ³⁾											
Residual ripple ⁴⁾	≤ 5 V _{PP}											
Current consumption ⁵⁾	≤ 35 mA											
Switching outputs	PNP, open collector: Q NPN, open collector: Q											
Output current I _A max.	100 mA											
Light receiver, switching mode	Light/dark switching per control wire: + V _S = light switching 0 V = dark switching											
Response time ⁶⁾ /switching sequ. max. ⁷⁾	≤ 2 ms; 250/s											
Connection types	PVC cable, 2 m ⁸⁾ 4 x 0.18 mm ² , Ø 3.8 mm M12 plug, 4-pin, 90° rotatable											
VDE protection class⁹⁾	□											
Circuit protection¹⁰⁾	A, B, C, D											
Enclosure rating	IP 67											
Ambient temperature	Operation - 25 °C ... + 55 °C Storage - 40 °C ... + 70 °C											
Weight	with connecting cable 2 m: Approx. 80 g with M12 plug, 4-pin: Approx. 40 g											
Material	Housing: ABS; optics: PC											

- 1) 90 % reflectance of material scanned
 - 2) Average service life T_A = + 25 °C; LED, red light 100,000 h
 - 3) Limit values, operation in short circuit protected network max. 8 A
 - 4) May not exceed or fall short of V_S tolerances
 - 5) Without load
 - 6) Signal operating time with ohmic load
 - 7) With dark/light ratio 1:1
 - 8) Do not bend cable below 0 °C
 - 9) Reference voltage 50 V DC
 - 10) A = V_S connections reverse-polarity protected
B = Outputs Q und Q̄ short-circuit protected
- C = Interference pulse suppression
D = Outputs overcurrent and short-circuit protected

Scanning distance

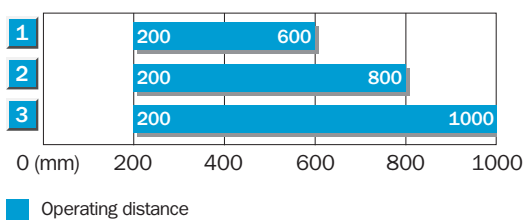

- 1 Scanning distance on black, 6 % remission
- 2 Scanning distance on grey, 18 % remission
- 3 Scanning distance on white, 90 % remission

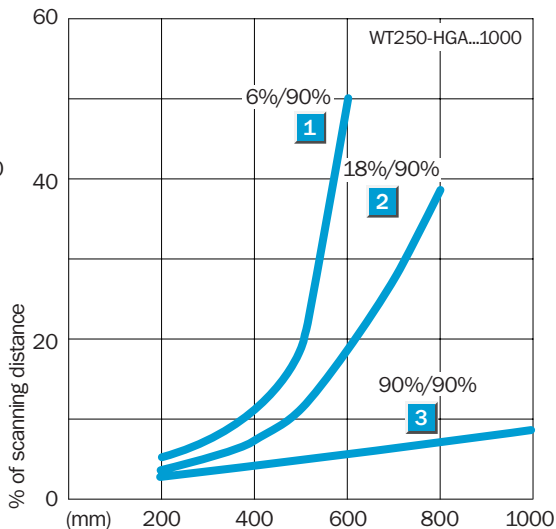

Order information

Type	Order no.
WT250-P172	6012647
WT250-P470	6012649
WT250-N172	6012644
WT250-N470	6012646

Scanning distance
200 ... 1000 mm
 Photoelectric proximity switch

- Universal voltage
- Background suppression
- Scanning distance adjustment (2 turns) with position indicator (270°)
- Visible red light as an alignment aid

Dimensional drawing

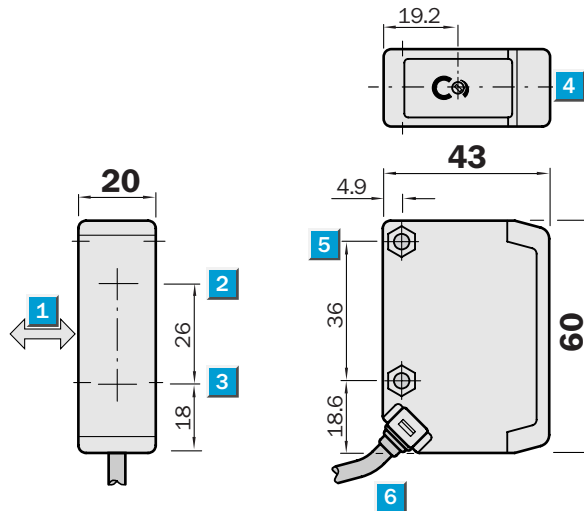

Adjustments possible

WT250-S172

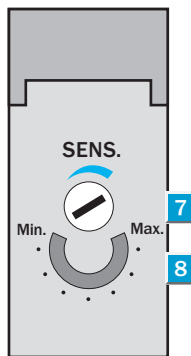

- 1 Standard direction of the material to be scanned
- 2 Transmission axis
- 3 Reception axis
- 4 Red LED signal strength indicator
- 5 Through hole Ø 4.2 mm, for M4 hexagon nut on both sides
- 6 Connection cable
- 7 Scanning distance adjustment (2 turns), over-turn protected
- 8 Position indicator for scanning distance setting (270°)

Connection type

WT250-S172

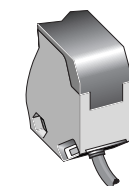
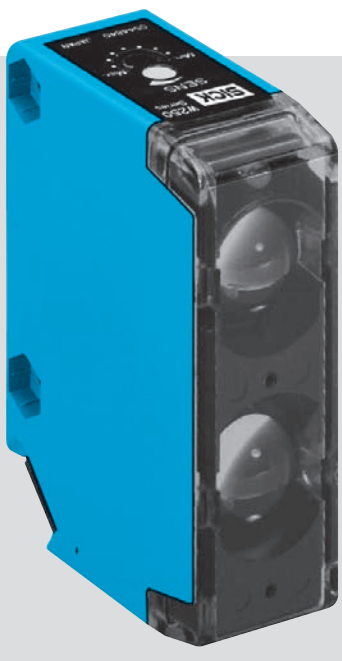

5 x 0.76 mm²

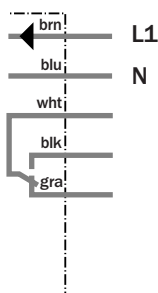

See chapter Accessories

Mounting systems*)

*) Mounting bracket included with delivery

Technical data		WT250-	S172										
Scanning distance, typ. max.	200 ... 1000 mm ¹⁾												
Recommended operating scanning dist.	200 ... 1000 mm ¹⁾												
Scanning distance, adjustable	Potentiometer, 2 rotations, with position indicator												
Light source²⁾	LED, visible red light												
Light spot diameter	Approx. 70 mm at 1000 mm												
Aperture angle sender	Approx. 3°												
Supply voltage V_S³⁾	12 ... 240 V DC												
	24 ... 240 V UC												
Power consumption	≤ 2 VA												
Switching outputs	Relay 1 x a, indirect-coupled ⁴⁾												
Switching current I max.	3 A/240 V AC; 3 A/30 V DC ⁵⁾												
Light receiver, switching mode	Light switching												
Response time/switching sequ. max. ⁶⁾	≤ 15 ms; 33/s												
Connection type	PVC cable ⁷⁾ , 2 m												
	5 x 0.76 mm ² , Ø 6.3 mm												
VDE protection class⁸⁾	□												
Circuit protection⁹⁾	A, C												
Enclosure rating	IP 67												
Ambient temperature	Operation - 25 °C ... + 55 °C												
	Storage - 40 °C ... + 70 °C												
Weight	Approx. 160 g												
Material	Housing: ABS; optics: PC												

1) 90 % reflectance of material scanned
 2) Average service life T_A = + 25 °C; LED, red light 100,000 h
 3) ± 10 %
 4) Ensure spark extinguishing for inductive or capacitive load
 5) Usage category to EN 60947-1, 15 AC, 13 DC
 6) With dark/light ratio 1:1
 7) Do not bend cable below 0 °C
 8) Reference voltage 250 V UC
 9) A = V_s connections reverse-polarity protected
 C = Interference pulse suppression

Scanning distance

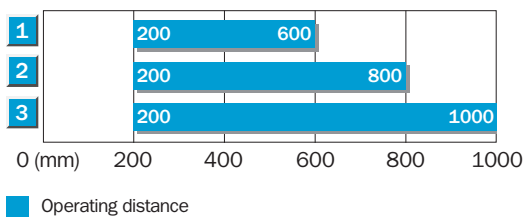

- 1 Scanning distance on black, 6 % remission
- 2 Scanning distance on grey, 18 % remission
- 3 Scanning distance on white, 90 % remission

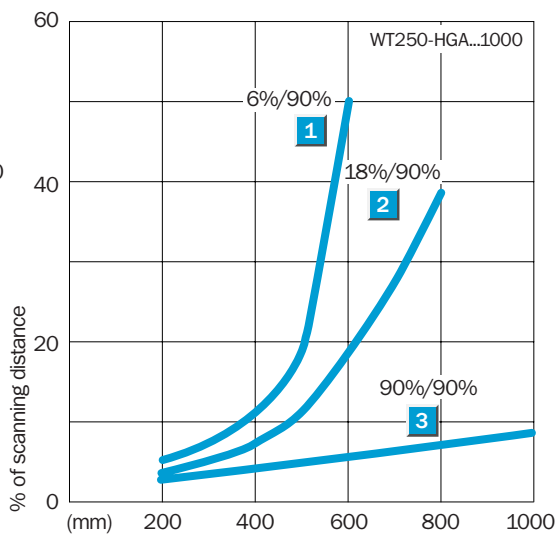

Order information

Type	Order no.
WT250-S172	6012650

Scanning distance
150 ... 500 mm

Photoelectric proximity switches

- Background suppression
- Scanning distance adjustment (2 turns) with position indicator (270°)
- Visible red light as an alignment aid
- Flexibility at the mounting position with rotatable plug connector

Dimensional drawing

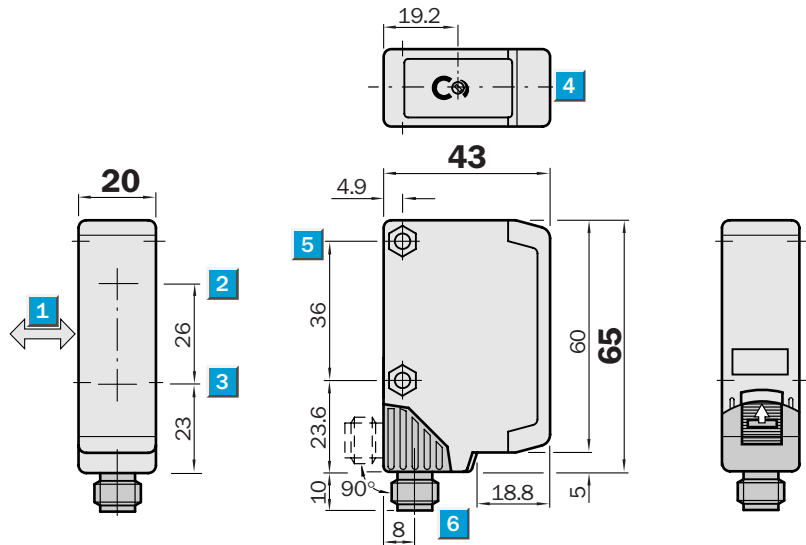

Adjustments possible

WT250-P162
WT250-P460
WT250-N162
WT250-N460

- 1 Standard direction of the material to be scanned
- 2 Transmission axis
- 3 Reception axis
- 4 Red LED signal strength indicator
- 5 Through hole \varnothing 4.2 mm, for M4 hexagon nut on both sides
- 6 Connection cable or M12 plug – 4-pin; plug position rotatable by 90° (V > H),
V → vertical final position
H → horizontal final position; can be locked with slider
- 7 Scanning distance adjustment (2 turns), over-turn protected
- 8 Position indicator for scanning distance setting (270°)

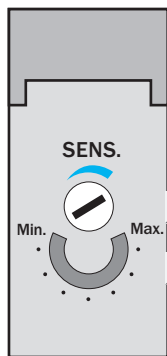

Connection types

WT250-P162	WT250-P460
WT250-N162	WT250-N460

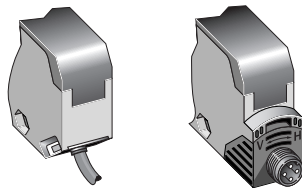

4 x 0,18 mm ²	4-pin, M12
--------------------------	------------

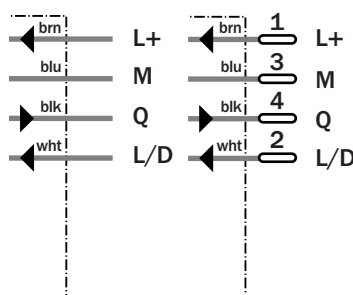

See chapter Accessories

- Cables and connectors
- Mounting systems*)

*) Mounting bracket included with delivery

Technical data		WT250-	P162	P460	N162	N460						
Scanning distance, typ. max.	150 ... 500 mm ¹⁾											
Recommended operating scanning dist.	150 ... 500 mm ¹⁾											
Scanning distance, adjustable	Potentiometer, 2 rotations, with position indicator											
Light source²⁾	LED, visible red light											
Light spot diameter	Approx. 35 mm at 500 mm											
Aperture angle sender	Approx. 3°											
Supply voltage V_S	10 ... 30 V DC ³⁾											
Residual ripple ⁴⁾	≤ 5 V _{PP}											
Current consumption ⁵⁾	≤ 35 mA											
Switching outputs	PNP, open collector: Q NPN, open collector: Q											
Output current I _A max.	100 mA											
Light receiver, switching mode	Light/dark switching per control wire: + V _S = light switching 0 V = dark switching											
Response time ⁶⁾ /switching sequ. max. ⁷⁾	≤ 2 ms; 250/s											
Connection types	PVC cable, 2 m ⁸⁾ 4 x 0.18 mm ² , Ø 3.8 mm M12 plug, 4-pin, 90° rotatable											
VDE protection class⁹⁾	□											
Circuit protection¹⁰⁾	A, B, C, D											
Enclosure rating	IP 67											
Ambient temperature	Operation - 25 °C ... + 55 °C Storage - 40 °C ... + 70 °C											
Weight	with connecting cable 2 m: Approx. 80 g with M12 plug, 4-pin: Approx. 40 g											
Material	Housing: ABS; optics: PC											

- 1) 90 % reflectance of material scanned
 - 2) Average service life T_A = + 25 °C; LED, red light 100,000 h
 - 3) Limit values, operation in short circuit protected network max. 8 A
 - 4) May not exceed or fall short of UV tolerances
 - 5) Without load
 - 6) Signal operating time with ohmic load
 - 7) With dark/light ratio 1:1
 - 8) Do not bend cable below 0 °C
 - 9) Reference voltage 50 V DC
 - 10) A = V_S connections reverse-polarity protected
B = Outputs Q und Q̄ short-circuit protected
- C = Interference pulse suppression
D = Outputs overcurrent and short-circuit protected

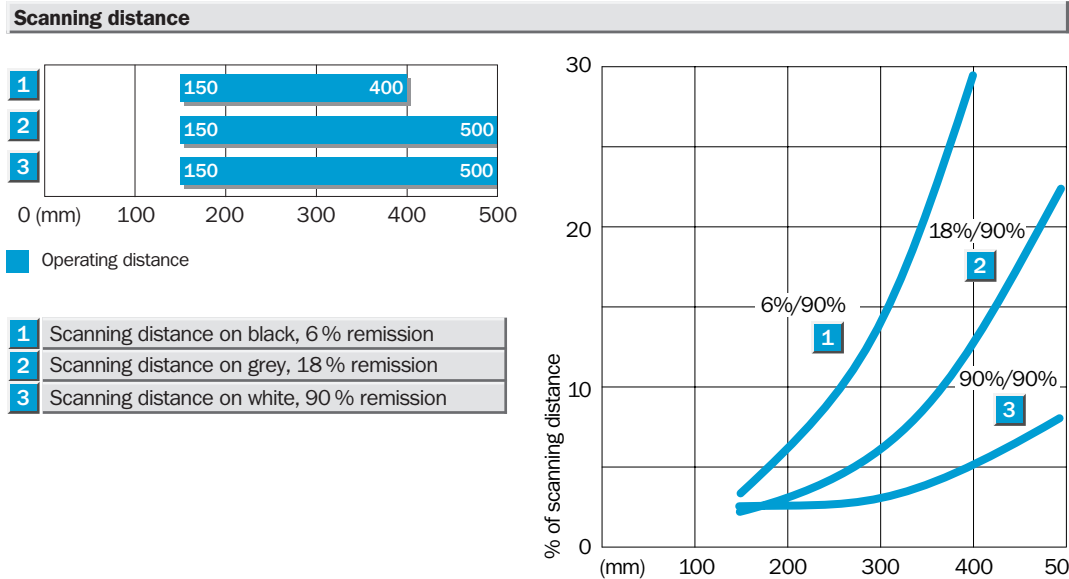

Order information	
Type	Order no.
WT250-P162	6010704
WT250-P460	6010706
WT250-N162	6010701
WT250-N460	6010703

Scanning distance
150 ... 500 mm
 Photoelectric proximity switch

- Universal voltage
- Background suppression
- Scanning distance adjustment (2 turns) with position indicator (270°)
- Visible red light as an alignment aid

Dimensional drawing

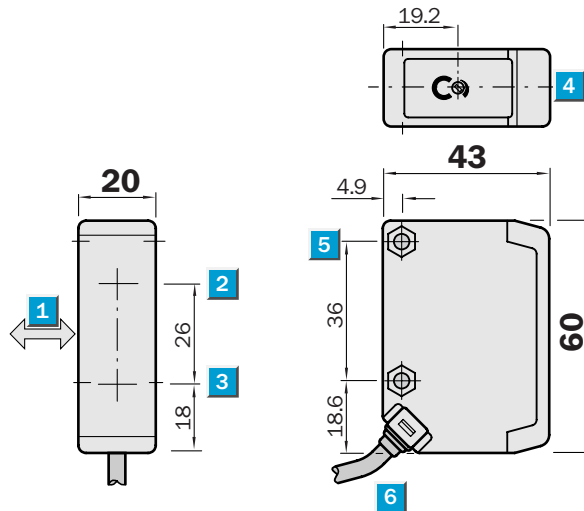

Adjustments possible

WT250-S162

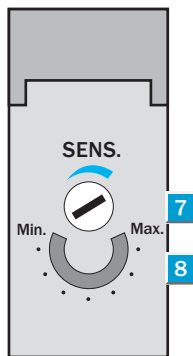

- 1 Standard direction of the material to be scanned
- 2 Transmission axis
- 3 Reception axis
- 4 Red LED signal strength indicator
- 5 Through hole Ø 4.2 mm, for M4 hexagon nut on both sides
- 6 Connection cable
- 7 Scanning distance adjustment (2 turns), over-turn protected
- 8 Position indicator for scanning distance setting (270°)

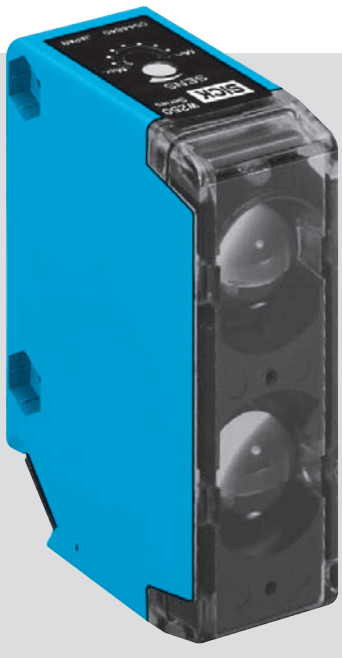

Connection type

WT250-S162

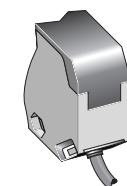

5 x 0.76 mm²

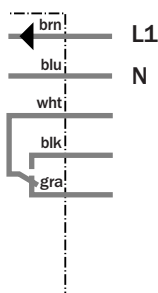

See chapter Accessories

Mounting systems*)

*) Mounting bracket included with delivery

Technical data		WT250-	S162										
Scanning distance, typ. max.	150 ... 500 mm ¹⁾												
Recommended operating scanning dist.	150 ... 500 mm ¹⁾												
Scanning distance, adjustable	Potentiometer, 2 rotations, with position indicator												
Light source²⁾	LED, visible red light												
Light spot diameter	Approx. 35 mm at 500 mm												
Aperture angle sender	Approx. 3°												
Supply voltage V_S³⁾	12 ... 240 V DC												
	24 ... 240 V UC												
Power consumption	≤ 2 VA												
Switching outputs	Relay 1 x a, indirect-coupled ⁴⁾												
Switching current I max.	3 A/240 V AC; 3 A/30 V DC ⁵⁾												
Light receiver, switching mode	Light switching												
Response time/switching sequ. max. ⁶⁾	≤ 15 ms; 33/s												
Connection type	PVC cable ⁷⁾ , 2 m												
	5 x 0.76 mm ² , Ø 6.3 mm												
VDE protection class⁸⁾	□												
Circuit protection⁹⁾	A, C												
Enclosure rating	IP 67												
Ambient temperature	Operation - 25 °C ... + 55 °C												
	Storage - 40 °C ... + 70 °C												
Weight	Approx. 160 g												
Material	Housing: ABS; optics: PC												

1) 90 % reflectance of material scanned
 2) Average service life T_A = + 25 °C; LED, red light 100,000 h
 3) ± 10 %
 4) Ensure spark extinguishing for inductive or capacitive load
 5) Usage category to EN 60947-1, 15 AC, 13 DC
 6) With dark/light ratio 1:1
 7) Do not bend cable below 0 °C
 8) Reference voltage 250 V UC
 9) A = V_S connections reverse-polarity protected
 C = Interference pulse suppression

Scanning distance

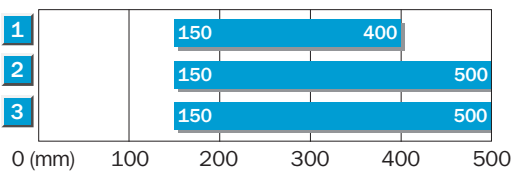

Operating distance

1	Scanning distance on black, 6% remission
2	Scanning distance on grey, 18% remission
3	Scanning distance on white, 90% remission

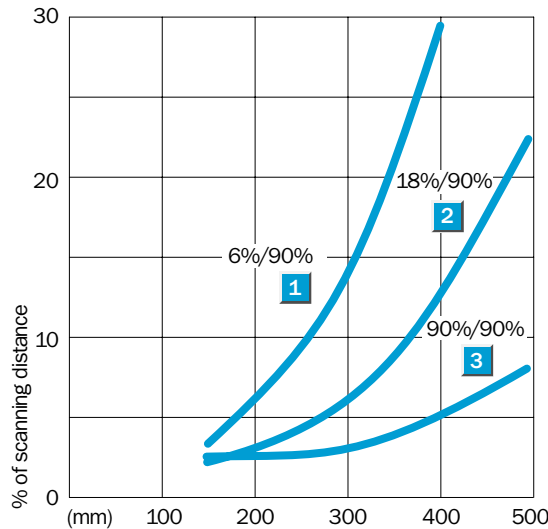

Order information

Type	Order no.
WT250-S162	6010707

Scanning distance
100 ... 300 mm

Photoelectric proximity switches

- Background suppression
- Scanning distance adjustment (2 turns) with position indicator (270°)
- Visible red light as an alignment aid
- M12 plug rotatable by 90°
- Flexibility at the mounting position with rotatable plug connector

Dimensional drawing

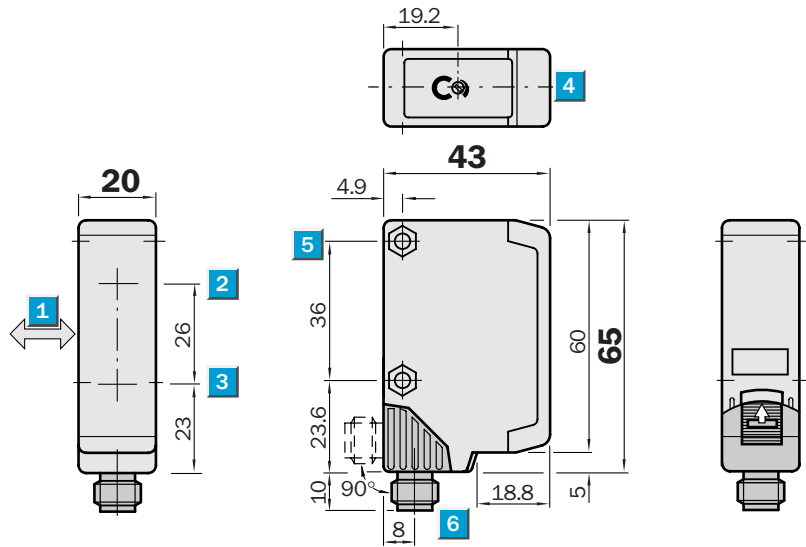

Adjustments possible

WT250-P142
WT250-P440
WT250-N142
WT250-N440

- 1 Standard direction of the material to be scanned
- 2 Transmission axis
- 3 Reception axis
- 4 Red LED signal strength indicator
- 5 Through hole Ø 4.2 mm, for M4 hexagon nut on both sides
- 6 Connection cable or M12 plug – 4-pin; plug position rotatable by 90° (V > H)
V → vertical final position
H → horizontal final position; can be locked with slider
- 7 Scanning distance adjustment (2 turns), over-turn protected
- 8 Position indicator for scanning distance setting (270°)

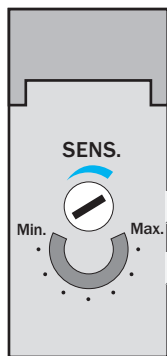

Connection types

WT250-P142	WT250-P440
WT250-N142	WT250-N440

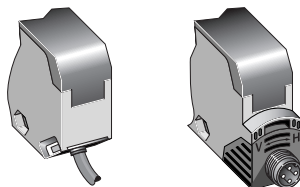

4 x 0,18 mm ²	4-pin, M12
--------------------------	------------

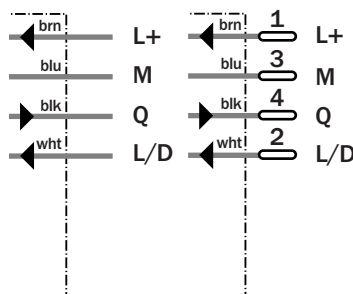

See chapter Accessories

Cables and connectors

Mounting systems*)

*) Mounting bracket included with delivery

Technical data		WT250-	P142	P440	N142	N440						
Scanning distance, typ. max.	100 ... 300 mm ¹⁾											
Recommended operating scanning dist.	100 ... 300 mm ¹⁾											
Scanning distance, adjustable	Potentiometer, 2 rotations, with position indicator											
Light source²⁾	LED, visible red light											
Light spot diameter	Approx. 25 mm at 300 mm											
Aperture angle sender	Approx. 3°											
Supply voltage V_S	10 ... 30 V DC ³⁾											
Residual ripple ⁴⁾	≤ 5 V _{PP}											
Current consumption ⁵⁾	≤ 35 mA											
Switching outputs	PNP, open collector: Q NPN, open collector: Q											
Output current I _A max.	100 mA											
Light receiver, switching mode	Light/dark switching per control wire: + V _S = light switching 0 V = dark switching											
Response time ⁶⁾ /switching sequ. max. ⁷⁾	≤ 2 ms; 250/s											
Connection types	PVC cable, 2 m ⁸⁾ 4 x 0.18 mm ² , Ø 3.8 mm M12 plug, 4-pin, 90° rotatable											
VDE protection class⁹⁾	□											
Circuit protection¹⁰⁾	A, B, C, D											
Enclosure rating	IP 67											
Ambient temperature	Operation - 25 °C ... + 55 °C Storage - 40 °C ... + 70 °C											
Weight												
with connecting cable 2 m	Approx. 80 g											
with M12 plug, 4-pin	Approx. 40 g											
Material	Housing: ABS; optics: PC											

- 1) 90 % reflectance of material scanned
- 2) Average service life T_A = + 25 °C; LED, red light 100,000 h
- 3) Limit values, operation in short circuit protected network max. 8 A
- 4) May not exceed or fall short of V_S tolerances
- 5) Without load
- 6) Signal operating time with ohmic load
- 7) With dark/light ratio 1:1, without time delay
- 8) Do not bend cable below 0 °C
- 9) Reference voltage 50 V DC
- 10) A = V_S connections reverse-polarity protected
B = Outputs Q and Q̄ short-circuit protected
C = Interference pulse suppression
D = Outputs overcurrent and short-circuit protected

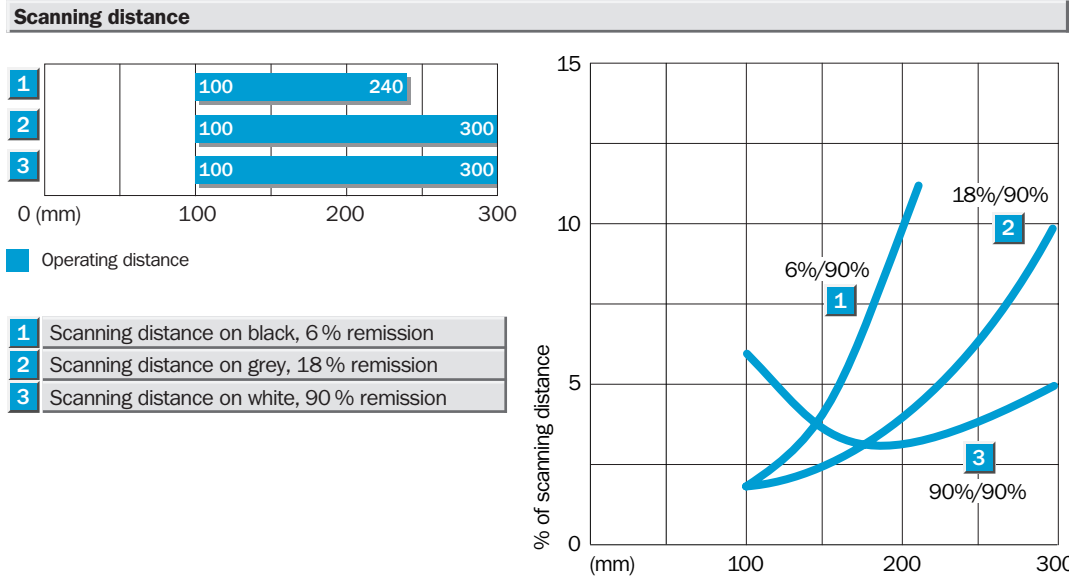

Order information	
Type	Order no.
WT250-P142	6010619
WT250-P440	6010621
WT250-N142	6010616
WT250-N440	6010618

Scanning distance
100 ... 300 mm
 Photoelectric proximity switch

- Universal voltage
- Background suppression
- Scanning distance adjustment (2 turns) with position indicator (270°)
- Visible red light as an alignment aid
- Relay switching output (SPDT)

Dimensional drawing

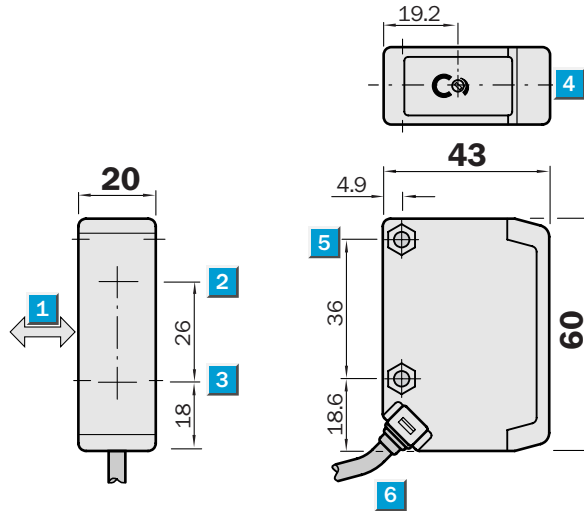

Adjustments possible

WT250-S142

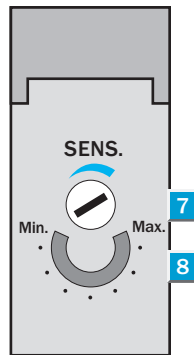

- 1 Standard direction of the scanned material
- 2 Transmission axis
- 3 Reception axis
- 4 Red LED signal strength indicator
- 5 Through hole Ø 4.2 mm, for M4 hexagon nut on both sides
- 6 Connection cable
- 7 Scanning distance adjustment (2 turns), over-turn protection
- 8 Position indicator for scanning distance setting (270°)

Connection type

WT250-S142

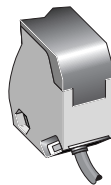
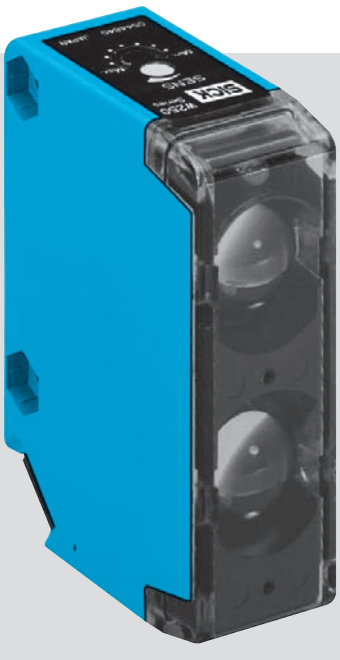

5 x 0.76 mm²

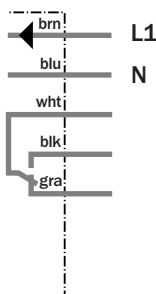

See chapter Accessories

Mounting systems*)

*) Mounting bracket included with delivery

Technical data		WT250-	S142										
Scanning distance, typ. max.	100 ... 300 mm ¹⁾												
Recommended operating scanning dist.	100 ... 300 mm ¹⁾												
Scanning distance, adjustable	Potentiometer, 2 rotations, with position indicator												
Light source²⁾	LED, visible red light												
Light spot diameter	Approx. 25 mm at 300 mm												
Aperture angle sender	Approx. 3°												
Supply voltage V_S³⁾	12 ... 240 V DC												
	24 ... 240 V UC												
Current consumption	≤ 2 VA												
Switching outputs	Relay 1 x a, indirect-coupled ⁴⁾												
Switching current I max.	3 A/240 V AC; 3 A/30 V DC ⁵⁾												
Light receiver, switching mode	Light switching												
Response time, switching sequ. max. ⁶⁾	≤ 15 ms; 33/s												
Connection type	PVC cable ⁷⁾ , 2 m												
	5 x 0.76 mm ² , Ø 6.3 mm												
VDE protection class⁸⁾	<input type="checkbox"/>												
Circuit protection⁹⁾	A, C												
Enclosure rating	IP 67												
Ambient temperature	Operation -25 °C ... +55 °C												
	Storage -40 °C ... +70 °C												
Weight	Approx. 160 g												
Material	Housing: ABS; optics: PC												

1) 90 % reflectance of material scanned
 2) Average service life at T_A = +25 °C; LED, red light 100,000 h
 3) ± 10 %
 4) Ensure spark extinguishing for inductive or capacitive load
 5) Usage category to EN 60947-1, 15 AC, 13 DC
 6) With light/dark ratio 1:1
 7) Do not bend cable below 0 °C
 8) Reference voltage 250 V UC
 9) A = V_S connections reverse-polarity protected
 C = Interference pulse suppression

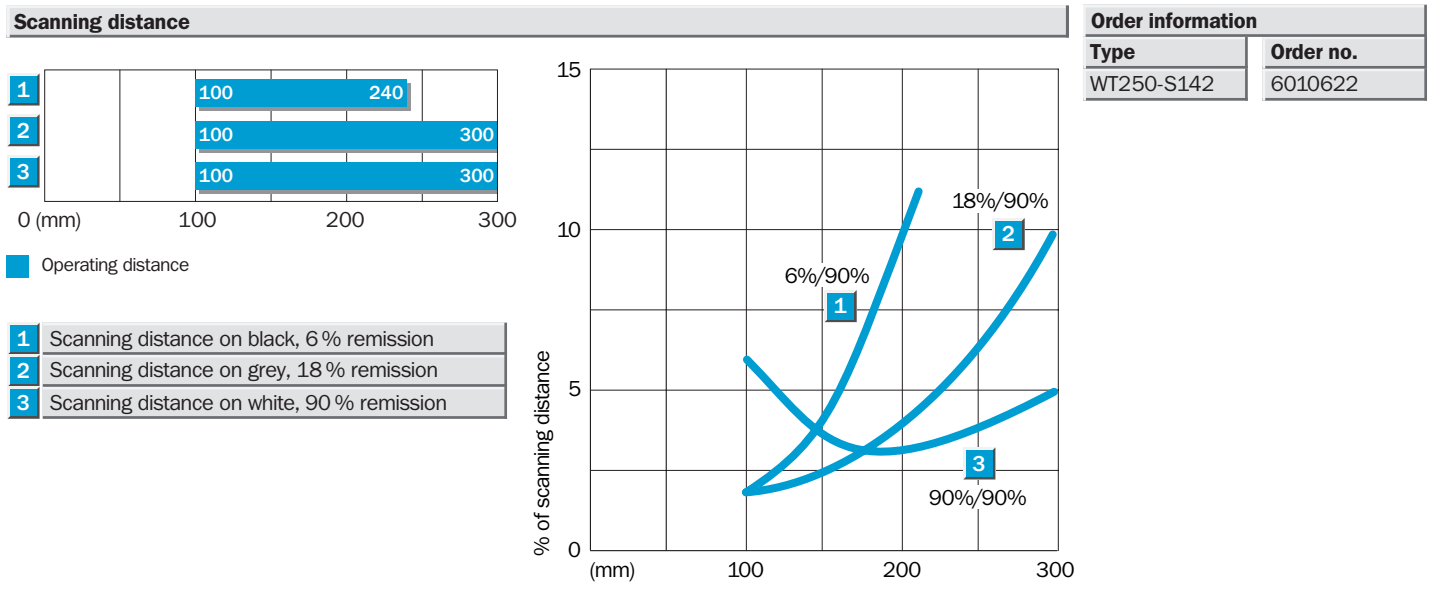

	Scanning range 0.01 ... 13.5 m (PL80 A)
	Scanning range 0.01 ... 9.0 m (P250)
Photoelectric reflex switches	

- Polarising filter, ensuring reliable detection of objects with reflective surfaces
- Robust, compact housing
- Adjustable sensitivity setting (2 turns) with position indicator (270°)
- Flexibility at the mounting position with rotatable plug connector

Dimensional drawing

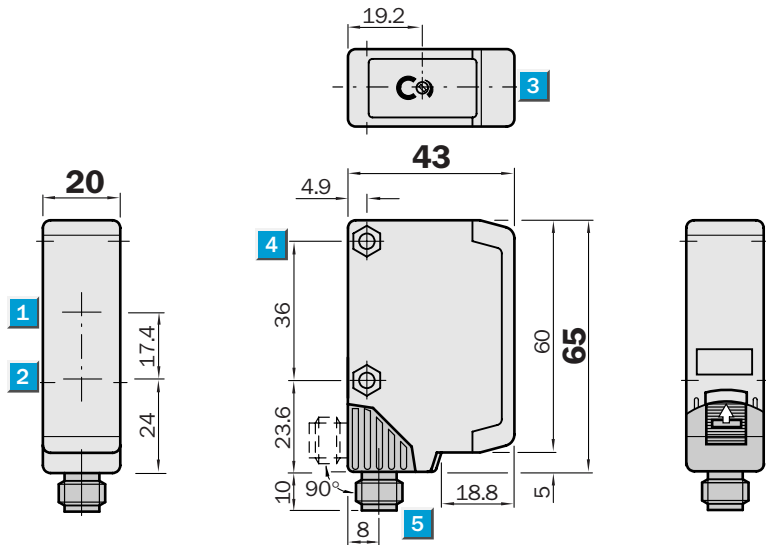

Adjustments possible

WL250-P132
WL250-P430
WL250-N132
WL250-N430

- 1 Reception axis
- 2 Transmission axis
- 3 Red LED signal strength indicator
- 4 Through hole Ø 4.2 mm, for M4 hexagon nut on both sides
- 5 Connection cable or M12 plug – 4-pin; plug position rotatable by 90° (V > H),
V → vertical final position
H → horizontal final position; can be locked with slider
- 6 Sensitivity control (2 U), over-turn protection
- 7 Position indicator for sensitivity setting (270°)

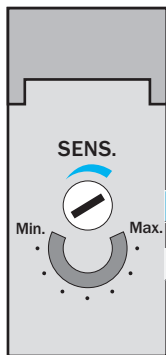

Connection types

WL250-P132	WL250-P430
WL250-N132	WL250-N430

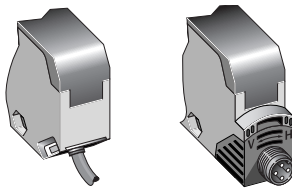

4 x 0.18 mm ²	4-pin, M12
--------------------------	------------

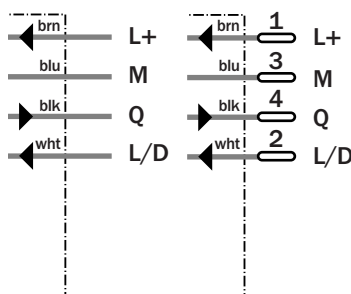

See chapter Accessories

Cables and connectors
Mounting systems*)
Reflectors **)

*) Mounting bracket included with delivery
**) Reflector P250 included with delivery

Technical data	WL250-	P132	P430	N132	N430
Scanning range , typ. max./on reflector	0.01 ... 13.5 m/PL 80 A				
typ. max./on reflector	0.01 ... 9 m/P250 (suppl. with equipment)				
Recommended operating range	0.01 ... 8 m/P250				
Sensitivity, adjustable	Potentiometer, 2 rotations, with position indicator				
Light source¹⁾	LED, visible red light with polarizing filter				
Light spot diameter	Approx. 400 mm at 8 m				
Aperture angle sender	Approx. 2.5°				
Supply voltage V_S	10 ... 30 VDC ²⁾				
Residual ripple ³⁾	≤ 5 V _{pp}				
Current consumption ⁴⁾	≤ 35 mA				
Switching outputs	PNP, open collector: Q NPN, open collector: Q				
Output current I _A max.	100 mA				
Light receiver, switching mode	Light/dark switching per control wire: + V _S = Light switching 0 V = dark switching				
Response time ⁵⁾ /switching sequ. max. ⁶⁾	≤ 0.5 ms; 1000/s				
Connection types	PVC cable, 2 m ⁷⁾ 4 x 0.18 mm ² , Ø 3.8 mm M12 plug, 4-pin, 90° rotatable				
VDE protection class⁸⁾	□				
Circuit protection⁹⁾	A, B, C, D				
Enclosure rating	IP 67				
Ambient temperature	Operation -25 °C ... +55 °C Storage -40 °C ... +70 °C				
Weight					
with connection cable 2 m	Approx. 80 g				
with M12 plug, 4-pin	Approx. 40 g				
Material	Housing: ABS; optics: PMMA				

¹⁾ Average service life at T_A = +25 °C; LED, red light 100,000 h
²⁾ Limit values, operation in short circuit protected network max. 8 A

³⁾ May not exceed or fall short of V_S tolerances
⁴⁾ Without load
⁵⁾ Signal operating time with ohmic load

⁶⁾ With light/dark ratio 1:1, without time delay
⁷⁾ Do not bend cable below 0 °C
⁸⁾ Reference voltage 50 V DC

⁹⁾ A = V_S connections reverse-polarity protected
B = Outputs Q and Q̄ short-circuit protected
C = Interference pulse suppression
D = Outputs overcurrent and short-circuit protected

Scanning range and operating reserve

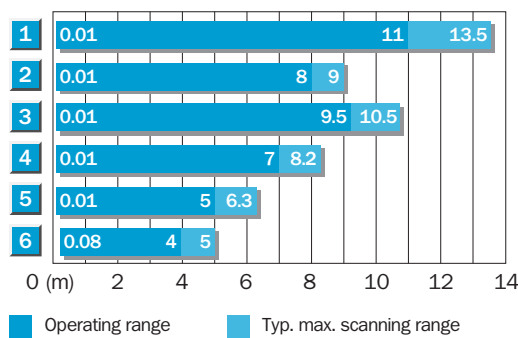

Reflector type	Operating range
1 PL 80 A	0.01 ... 11.0 m
2 P 250	0.01 ... 8.0 m
3 PL 50 A or PL 40 A	0.01 ... 9.5 m
4 PL 30 A or PL 31 A	0.01 ... 7.0 m
5 PL 20 A	0.01 ... 5.0 m
6 Reflective tape Diamond Grade	0.08 ... 4.0 m

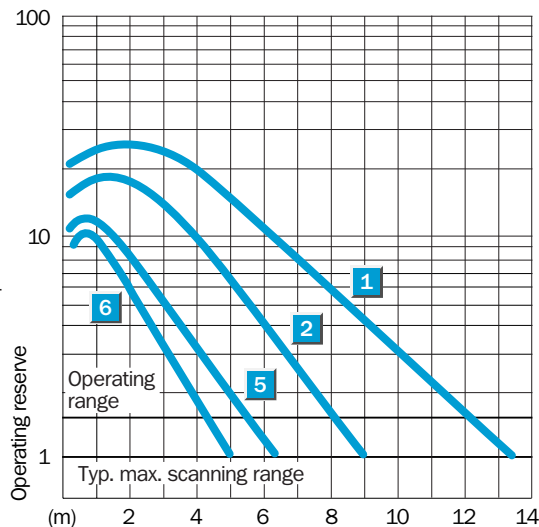

Order information

Type	Order no.
WL250-P132	6010608
WL250-P430	6010610
WL250-N132	6010605
WL250-N430	6010607

	Scanning range 0.01 ... 13.5 m (PL80 A)
	Scanning range 0.01 ... 9.0 m (P250)
Photoelectric reflex switches	

- Universal voltage
- Polarising filter, ensuring reliable detection of objects with reflective surfaces
- Robust, compact housing
- Red light LED sender as an alignment aid
- Relay switching output (SPDT)

Dimensional drawing

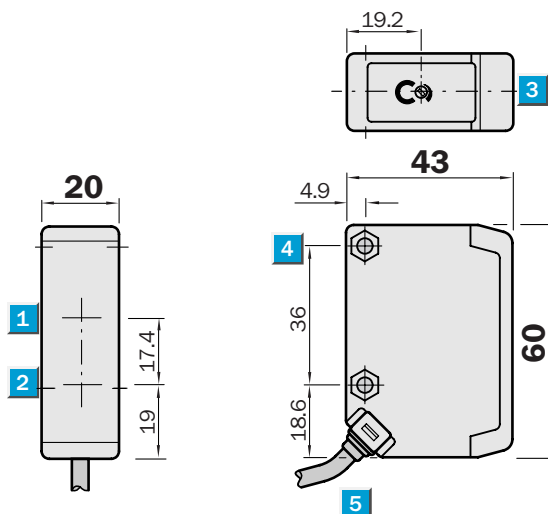

Adjustments possible

WL250-S132

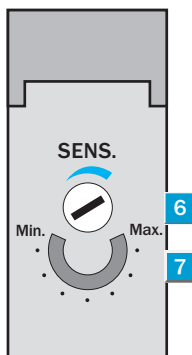

- 1 Reception axis
- 2 Transmission axis
- 3 Red LED signal strength indicator
- 4 Through hole Ø 4.2 mm, for M4 hexagon nut on both sides
- 5 Connection cable
- 6 Sensitivity adjustment (2 turns), over-turn protection
- 7 Position indicator for sensitivity setting (270°)

Connection type

WL250-S132

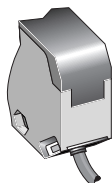

5 x 0.76 mm²

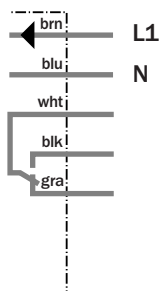

See chapter Accessories

Mounting systems*)

Reflectors **)

*) Mounting bracket included with delivery

**) Reflector P250 included with delivery

Technical data		WL250-	S132										
Scanning range , typ. max./on reflector	0.01 ... 13.5 m/PL 80 A												
	typ. max./on reflector	0.01 ... 9 m/P250 (suppl. with equipment)											
Recommended operating range	0.01 ... 8 m/P250												
Sensitivity, adjustable	Potentiometer, 2 rotations, with position indicator												
Light source¹⁾	LED, visible red light with polarizing filter												
Light spot diameter	Approx. 400 mm at 8 m												
Aperture angle sender	Approx. 2.5°												
Supply voltage V_S²⁾	12 ... 240 V DC												
	24 ... 240 V UC												
Current consumption	≤ 2 VA												
Switching outputs	Relay 1 x u, indirect-coupled ³⁾												
Switching current I max.	3 A/240 V AC; 3 A/30 V DC ⁴⁾												
Light receiver, switching mode	Light switching												
Response time, switching sequ. max. ⁵⁾	≤ 15 ms; 33/s												
Connection type	PVC cable, 2 m ⁵⁾												
	5 x 0.76 mm ² , Ø 6.3 mm												
VDE protection class⁷⁾	□												
Circuit protection⁸⁾	A, C												
Enclosure rating	IP 67												
Ambient temperature	Operation - 25 °C ... + 55 °C												
	Storage - 40 °C ... + 70 °C												
Weight	Approx. 160 g												
Material	Housing: ABS; optics: PMMA												

1) Average service life at $T_A = +25\text{ °C}$;
LED, red light 100,000 h

2) ± 10 %

3) Ensure spark extinguishing with inductive
or capacitive load

4) Usage category to EN 60947-1, 15 AC,
13 DC

5) With light/dark ratio 1:1,
without time delay

6) Do not bend cable below 0 °C

7) Reference voltage 250 V UC

8) A = V_S connections reverse-polarity
protected

C = Interference pulse suppression

Scanning range and operating reserve

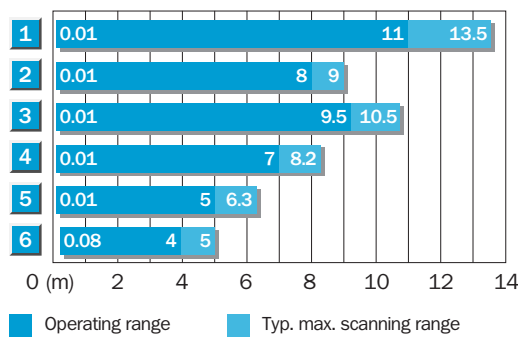

Reflector type	Operating range
1 PL 80 A	0.01 ... 11.0 m
2 P 250	0.01 ... 8.0 m
3 PL 50 A or PL 40 A	0.01 ... 9.5 m
4 PL 30 A or PL 31 A	0.01 ... 7.0 m
5 PL 20 A	0.01 ... 5.0 m
6 Reflective tape Diamond Grade	0.08 ... 4.0 m

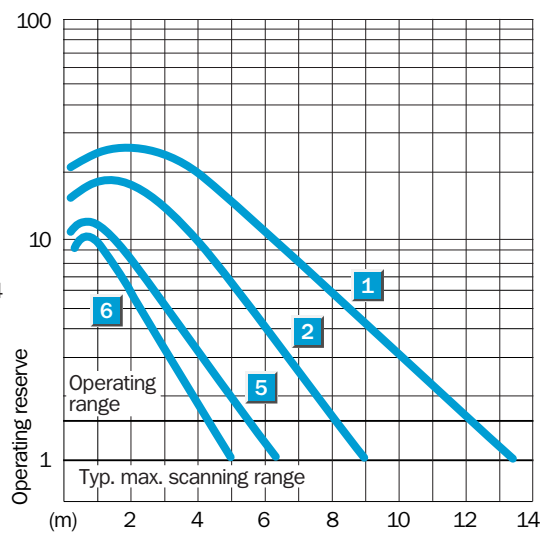

Order information

Type	Order no.
WL250-S132	6010611

Scanning range
0 ... 25 m

Through-beam photoelectric switches

- Robust, compact housing
- Red light LED sender as an alignment aid
- Flexibility at the mounting position with rotatable plug connector

Dimensional drawing

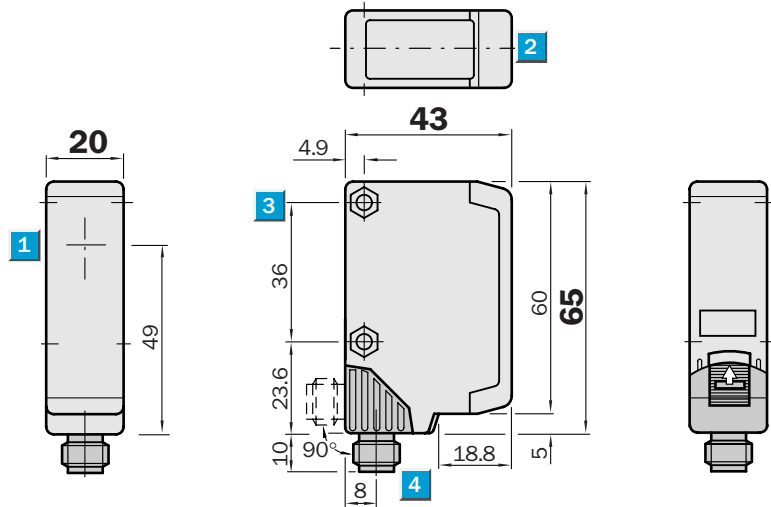

- 1** Centre of the optical axis, sender (WS250), receiver (WE250)
- 2** Red LED signal strength indicator (only receiver WE250)
- 3** Through hole Ø 4.2 mm, for M4 hexagon nut on both sides
- 4** Connection cable or M12 plug – 4-pin; plug position rotatable by 90° (V > H), V → vertical final position, H → horizontal final position; can be locked with slider



Connection types

WS/WE250-P142
WS/WE250-N142

WS/WE250-P440
WS/WE250-N440

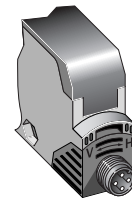
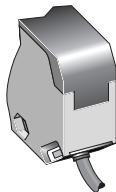

2 x 0.18 mm²

4 x 0.18 mm²

4-pin, M12

4-pin, M12

Sender

WS250-D142

Receiver

WE250-P142
WE250-N142

Sender

WS250-D 440

Receiver

WE250-P 440
WE250-N 440

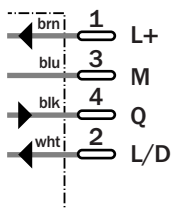
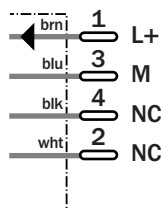
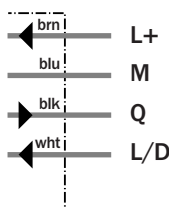
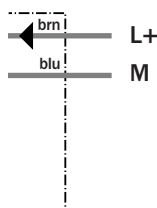

See chapter Accessories

Cables and connectors
Mounting systems*)

*) Mounting bracket included with delivery

Technical data		WS/WE250-	P142	P440	N142	N440						
Scanning range, typ. max.	0 ... 25 m											
Operating range	0 ... 20 m											
Light source¹⁾	LED, visible red light											
Light spot diameter	Approx. 1.5 m at 20 m											
Aperture angle sender	Approx. 4°											
Reception angle	Approx. 20°											
Supply voltage V_S	10 ... 30 V DC ²⁾											
Residual ripple ³⁾	≤ 5 V _{SS}											
Current consumption⁴⁾												
Sender	≤ 20 mA											
Receiver	≤ 35 mA											
Switching outputs	PNP, open collector: Q											
	NPN, open collector: Q											
Output current I _A max.	100 mA											
Light receiver, switching mode	Light/dark switching per control wire:											
	+ V _S = light switching											
	0 V = dark switching											
Response time ⁵⁾ /switching sequ. max. ⁶⁾	≤ 0.5 ms; 1000/s											
Connection types	PVC cable ⁷⁾ , 2 m											
Sender WS	2 x 0.18 mm ² , Ø 3.8 mm											
Receiver WE	4 x 0.18 mm ² , Ø 3.8 mm											
	M12 plug, 4-pin, 90° rotatable											
VDE protection class⁸⁾	□											
Circuit protection⁹⁾												
Sender	A											
Receiver	A, B, C, D											
Enclosure rating	IP 67											
Ambient temperature	Operation - 25 °C ... + 55 °C											
	Storage - 40 °C ... + 70 °C											
Weight												
with connection cable 2 m	Approx. 150 g											
with M12 plug, 4-pin	Approx. 70 g											
Material	Housing: ABS; optics: PC											

¹⁾ Average service life at T_A = + 25 °C; LED, red light 100,000 h
²⁾ Limit values, operation in short circuit protected network max. 8 A

³⁾ May not exceed or fall short of V_S tolerances
⁴⁾ Without load
⁵⁾ Signal operating time with ohmic load

⁶⁾ With light/dark ratio 1:1
⁷⁾ Do not bend cable below 0 °C
⁸⁾ Reference voltage 50 V DC
⁹⁾ A = V_S connections reverse-polarity protected

B = Outputs Q and Q short-circuit protected
 C = Interference pulse suppression
 D = Outputs overcurrent and short-circuit protected

Operating range and reserve

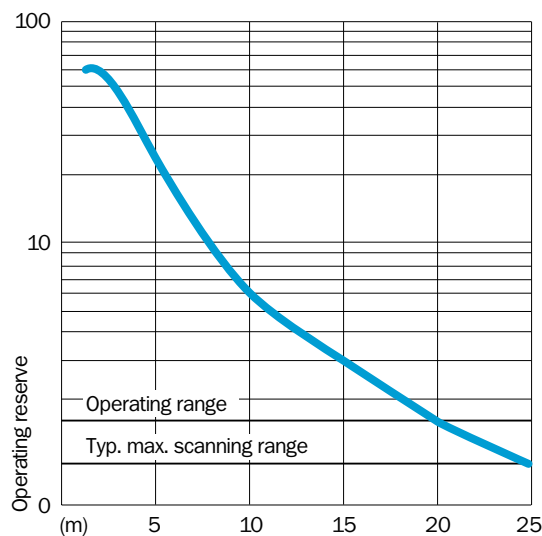
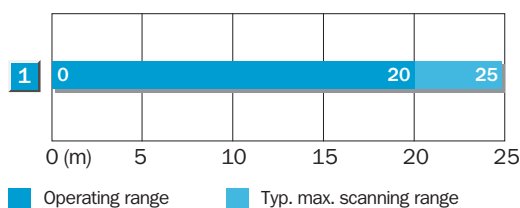

Order information

Type	Order no.
WS/WE250-P142	6026266
WS/WE250-P440	6026268
WS/WE250-N142	6026263
WS/WE250-N440	6026265

 **Scanning range**
0 ... 25 m

Through-beam photoelectric switch

- Universal voltage
- Robust, compact housing
- Red light LED sender as an alignment aid
- Relay switching output (SPDT)

Dimensional drawing

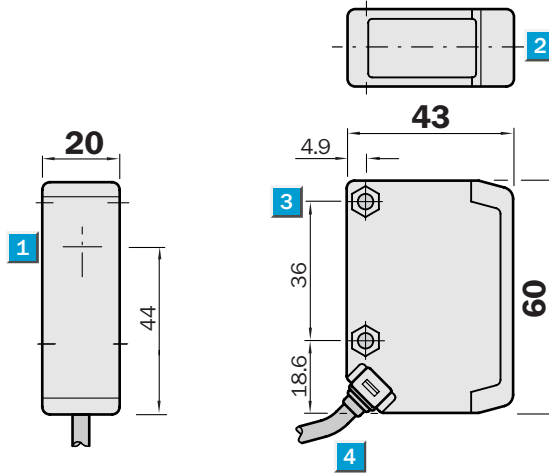

Adjustments possible

WE250-S132

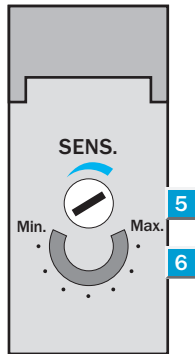

- 1 Center of the optics axis, sender (WS250), receiver (WE250)
- 2 Red LED signal strength indicator (only receiver WE250)
- 3 Through hole \varnothing 4.2 mm, for M4 hexagon nut on both sides
- 4 Connection cable
- 5 Sensitivity adjustment (2 turns), over-turn protection
- 6 Position indicator for sensitivity setting (270°)



Connection type

WS/WE250-S132

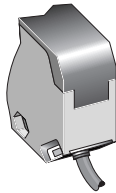

Sender 2 x 0.76 mm²
WS250-U132

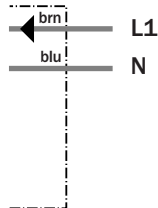

See chapter Accessories

Mounting systems*)

Receiver 5 x 0.76 mm²
WE250-S132

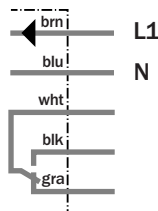

*) Mounting bracket included with delivery

Technical data		WS/WE250-	S132									
Scanning range, typ. max.	0 ... 25 m											
Operating range	0 ... 20 m											
Sensitivity adjustable (WE)	Potentiometer, 2 rotations, with position indicator											
Light source¹⁾	LED, visible red light											
Light spot diameter	Approx. 1.5 m at 20 m											
Aperture angle sender	Approx. 4°											
Reception angle	Approx. 20°											
Supply voltage V_S²⁾	12 ... 240 V DC 24 ... 240 V UC											
Current consumption												
Sender	≤ 2 VA											
Receiver	≤ 2 VA											
Switching outputs	Relay 1 x u indirect-coupled ³⁾											
Switching current I max.	3 A/240 V AC; 3 A/30 V DC ⁴⁾											
Light receiver, switching mode	Light switching											
Response time, switching sequ. max. ⁵⁾	≤ 15 ms; 33/s											
Connection type	PVC cable ⁶⁾ , 2 m											
Sender WS	2 x 0.76 mm ² , Ø 6.3 mm											
Receiver WE	5 x 0.76 mm ² , Ø 6.3 mm											
VDE protection class⁷⁾	□											
Circuit protection⁸⁾												
Sender	A											
Receiver	A, C											
Enclosure rating	IP 67											
Ambient temperature	Operation -25 °C ... +55 °C Storage -40 °C ... +70 °C											
Weight	Approx. 290 g											
Material	Housing: ABS; optics: PC											

1) Average service life at T_A = +25 °C; LED, red light 100,000 h

2) ± 10%

3) Ensure spark extinguishing with inductive or capacitive load

4) Usage category to EN 60947-1, 15 AC, 13 DC

5) With light/dark ratio 1:1

6) Do not bend cable below 0 °C

7) 250 V UC

8) A = V_S connections reverse-polarity protected
C = Interference pulse suppression

Operating range and reserve

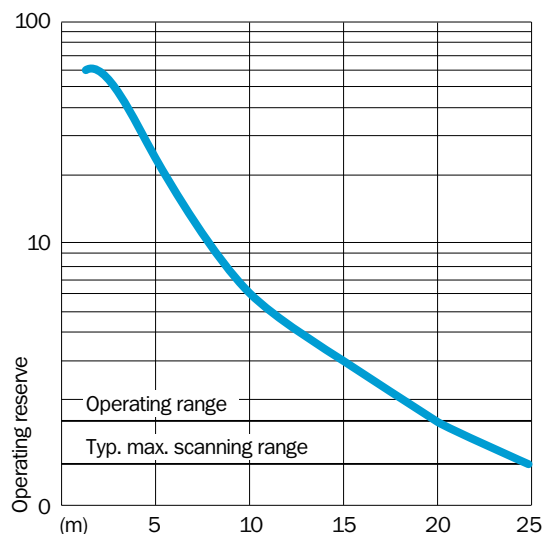
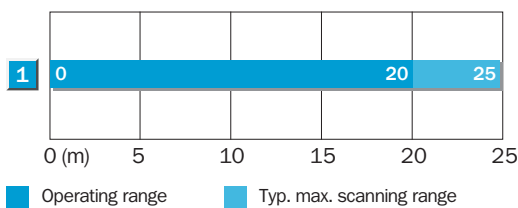

Order information

Type	Order no.
WS/WE250-S132	6010603